

# Eigenvalues of larger Toeplitz matrices: the asymptotic approach.

Sergei M. Grudsky

(CINVESTAV, Mexico-City, Mexico)

Moscow, October 2010

# Main object.

Spectral properties of larger finite Toeplitz matrices

$$A_n = (a_{j-k})_{j,k=0}^{n-1} = \begin{pmatrix} a_0 & a_{-1} & a_{-2} & \dots & a_{-(n-1)} \\ a_1 & a_0 & a_{-1} & \dots & a_{-(n-2)} \\ a_2 & a_1 & a_0 & \dots & a_{-(n-3)} \\ \vdots & \vdots & \vdots & \ddots & \vdots \\ a_{n-1} & a_{n-2} & a_{n-3} & \dots & a_0 \end{pmatrix}.$$

Eigenvalues, singular values, condition numbers, invertibility and norms of inverses, e.t.c.

$n \sim 1000$  is a business of numerical linear algebra.

Statistical physics -  $n = 10^7 - 10^{12}$  - is a business of asymptotic theory.

# Limit matrix.

$$A = (a_{j-k})_{j,k=0}^{\infty} = \begin{pmatrix} a_0 & a_{-1} & a_{-2} & \dots \\ a_1 & a_0 & a_{-1} & \dots \\ a_2 & a_1 & a_0 & \dots \\ \dots & \dots & \dots & \dots \end{pmatrix}$$

## Question

Does spectral properties of  $A$  is a limit (in some sense) of  $\{A_n\}$  or not?

Yes:

- properties invertibility and norms of inverses (for a larger class of symbols);
- limiting set in a case of real-value symbols.

No:

- distribution of eigenvalue in general (complex-value) case.

# Content of the Course.

1. Infinite Toeplitz matrices.
2. Finite section method, stability.
3. Szegő's limit theorems.
4. Limiting spectral set of sequences of Toeplitz matrices.
5. Asymptotics of eigenvalues.

# Literature

1. A. Böttcher, S. Grudsky. *Toeplitz Matrices, Asymptotic Linear Algebra, and Functional Analysis*. Hindustan Book Agency, New Delhi, 2000 and Birkhäuser Verlag, Basel, Boston, Berlin, 2000.
2. A. Böttcher, B. Silbermann. *Introduction to Large Truncated Toeplitz Matrices*. Universitext, Springer-Verlag, New York, 1999.
3. Albrecht Böttcher and Sergei M. Grudsky. *Spectral Properties of Banded Toeplitz Matrices*. SIAM, Philadelphia, 2005, pp. 411.
4. Albrecht Böttcher, Sergei M. Grudsky and Egor A. Maksimenko. *Pushing the envelope of the test functions in the Szegő and Avram-Parter theorems*. *Linea Algebra and its Applications* 429 (2008), 346-366.

5. Albrecht Böttcher, Sergei M. Grudsky, Egor A. Maksimenko. *On the structure of the eigenvectors of large Hermitian Toeplitz band matrices*. Operator Theory: Advances and Applications 210 (2010), 15-36.
6. Albrecht Böttcher, Sergei M. Grudsky, Egor A. Maksimenko. *Inside the eigenvalues of certain Hermitian Toeplitz band matrices*. J. of Computational and Applied Mathematics 233 (2010), 2245-2264.

# Infinite Toeplitz Matrices

## Boundedness

Given a sequence  $\{a_n\}_{n=-\infty}^{\infty}$  of complex numbers,  $a_n \in \mathbf{C}$ , when does the matrix

$$A = \begin{pmatrix} a_0 & a_{-1} & a_{-2} & \dots \\ a_1 & a_0 & a_{-1} & \dots \\ a_2 & a_1 & a_0 & \dots \\ \dots & \dots & \dots & \dots \end{pmatrix} \quad (1)$$

induce a bounded operator on  $l^2 := l^2(\mathbf{Z}_+)$ , where  $\mathbf{Z}_+$  is the set of nonnegative integers,  $\mathbf{Z}_+ := \{0, 1, 2, \dots\}$ ? The answer is classical result by Otto Toeplitz.

## Theorem (Toeplitz 1911)

The matrix (1) defines a bounded operator on  $l^2$  if and only if the numbers  $\{a_n\}$  are the Fourier coefficients of some function  $a \in L^\infty(\mathbf{T})$ ,

$$a_n = \frac{1}{2\pi} \int_0^{2\pi} a(e^{i\theta}) e^{-in\theta} d\theta, \quad n \in \mathbf{Z}. \quad (2)$$

In that case the norm of the operator given by (1) equals

$$\|a\|_\infty := \operatorname{ess\,sup}_{t \in \mathbf{T}} |a(t)|.$$



*Proof.* We denote by  $L^2 := L^2(\mathbf{T})$  and  $L^\infty := L^\infty(\mathbf{T})$  the usual Lebesgue spaces on the complex unit circle  $\mathbf{T}$ . The multiplication operator

$$M(a) : L^2 \rightarrow L^2, \quad f \mapsto af$$

is bounded if and only if  $a$  is in  $L^\infty$ , in which case  $\|M(a)\| = \|a\|_\infty$ . An orthonormal basis of  $L^2$  is given by  $\{e_n\}_{n=-\infty}^\infty$  where

$$e_n(t) = \frac{1}{\sqrt{2\pi}} t^n, \quad t \in \mathbf{T}.$$

The matrix representation of  $M(a)$  with respect to the basis  $\{e_n\}$  is easily seen to be

$$L(a) := \left( \begin{array}{ccc|cccc} \dots & \dots & \dots & \dots & \dots & \dots & \dots \\ \dots & a_0 & a_{-1} & a_{-2} & a_{-3} & a_{-4} & \dots \\ \dots & a_1 & a_0 & a_{-1} & a_{-2} & a_{-3} & \dots \\ \hline \dots & a_2 & a_1 & a_0 & a_{-1} & a_{-2} & \dots \\ \dots & a_3 & a_2 & a_1 & a_0 & a_{-1} & \dots \\ \dots & a_4 & a_3 & a_2 & a_1 & a_0 & \dots \\ \dots & \dots & \dots & \dots & \dots & \dots & \dots \end{array} \right) \quad (3)$$

where the  $a_n$ 's are defined by (2). Thus, we arrive at the conclusion that  $L(a)$  defines a bounded operator on  $l^2(\mathbf{Z})$  if and only if  $a \in L^\infty$  and that  $\|L(a)\| = \|a\|_\infty$  in this case.

The matrix (1) is the lower right quarter of  $L(a)$ , that is we may think of  $A$  as the compression of  $L(a)$  to the space  $l^2 = l^2(\mathbf{Z}_+)$ . This implies that if  $a \in L^\infty$ , then

$$\|A\| \leq \|L(a)\| = \|a\|_\infty. \quad (4)$$

For a natural number  $n$ , let  $S_n$  be the projection on  $l^2(\mathbf{Z})$  given by

$$S_n : (x_k)_{k=-\infty}^{\infty} \mapsto (\dots, 0, 0, x_{-n}, \dots, x_{-1}, x_0, x_1, x_2, \dots).$$

The matrix representation of the operator  $S_n L(a) S_n | \text{Im } S_n$  results from (3) by deleting all rows and columns indexed by a number in  $\{-(n+1), -(n+2), \dots\}$ . Hence,  $S_n L(a) S_n | \text{Im } S_n$  has the matrix (1) as its matrix representation. This shows that

$$\|A\| = \|S_n L(a) S_n\|. \quad (5)$$

Because  $S_n$  converges strongly (=pointwise) to the identity operator on  $l^2(\mathbf{Z})$ , it follows that  $S_n L(a) S_n \rightarrow L(a)$  strongly, whence

$$\|L(a)\| \leq \liminf_{n \rightarrow \infty} \|S_n L(a) S_n\|. \quad (6)$$

From (5) and (6) we see that  $L(a)$  and thus  $M(a)$  must be bounded whenever  $A$  is bounded and that

$$\|L(a)\| \leq \|A\|. \quad (7)$$

Consequently,  $A$  is bounded if and only if  $a \in L^\infty$ , in which case (4) and (7) give the equality  $\|A\| = \|a\|_\infty$ . ■

Clearly, if there is a function  $a \in L^\infty$  satisfying (2), then this function (or, to be more precise, the equivalence class of  $L^\infty$  containing it) is unique.

We therefore denote both the matrix (1) and the operator it induces on  $\ell^2$  by  $T(a)$ . **The function  $a$  is in this context referred to as the symbol of the Toeplitz matrix/operator  $T(a)$ .**

## Compactness and Selfadjointness

In this section we cite two very simple but instructive results. They reveal that Toeplitz operators with properly complex-valued symbol cannot be tackled by the tools available for compact and selfadjoint operators.

### Proposition (Gohberg 1952)

*The only compact Toeplitz operator is the zero operator.*

*Proof.* Let  $a \in L^\infty$  and suppose  $T(a)$  is compact. Let  $Q_n$  be the projection

$$Q_n : l^2 \rightarrow l^2, \quad (x_0, x_1, x_2, \dots) \mapsto (0, \dots, 0, x_n, x_{n+1}, \dots). \quad (8)$$

As  $Q_n \rightarrow 0$  strongly and  $T(a)$  is compact, it follows that  $\|Q_n T(a) Q_n\|$  converges strongly to 0. But the compression  $Q_n T(a) Q_n|_{\text{Im } Q_n}$  has the same matrix as  $T(a)$  whence  $\|T(a)\| = \|Q_n T(a) Q_n\|$ . Consequently,  $T(a) = 0$ . ■

Because  $T(a) - \lambda I = T(a - \lambda)$  for every  $\lambda \in \mathbf{C}$ , we learn from Proposition 2 that  $T(a)$  is never of the form  $\lambda I +$  a compact operator unless  $T(a) = \lambda I$ .

### Proposition

*The Toeplitz operator  $T(a)$  is selfadjoint if and only if  $a$  is real-valued.*

*Proof.* This is obvious:  $T(a)$  is selfadjoint if and only if  $a_n = \overline{a_{-n}}$  for all  $n$ , which happens if and only if  $a(t) = \overline{a(\overline{t})}$  for all  $t \in \mathbf{T}$ . ■

## $C^*$ -Algebras

A *Banach algebra* is a Banach space  $\mathcal{A}$  with an associative and distributive multiplication such that  $\|ab\| \leq \|a\| \|b\|$  for all  $a, b \in \mathcal{A}$ . If a Banach algebra  $\mathcal{A}$  has a unit element, which is usually denoted by  $e$ ,  $1$ , or  $I$ , it is referred to as a *unital Banach algebra*. A conjugate-linear map  $a \mapsto a^*$  of a Banach algebra into itself is called an *involution* if  $a^{**} = a$  and  $(ab)^* = b^*a^*$  for all  $a, b \in \mathcal{A}$ . Finally, a  *$C^*$ -algebra* is a Banach algebra with an involution such that  $\|a^*a\| = \|a\|^2$  for all  $a \in \mathcal{A}$ . In more detail, we can define a  $C^*$ -algebra as follows. A  $C^*$ -algebra is a set  $\mathcal{A}$  with four algebraic operations and a norm. The four algebraic operations are multiplication by scalars in  $\mathbf{C}$ , addition, multiplication, and involution. The following axioms must be satisfied for the operations:

- (1) the axioms of a linear space for scalar multiplication and addition;
- (2)  $a(bc) = (ab)c$  for all  $a, b, c \in \mathcal{A}$ ;
- (3)  $a(b + c) = ab + ac$ ,  $(a + b)c = ac + bc$  for all  $a, b, c \in \mathcal{A}$ ;
- (4)  $(\lambda a)^* = \bar{\lambda}a^*$ ,  $(a + b)^* = a^* + b^*$ ,  $(ab)^* = b^*a^*$  for all  $\lambda \in \mathbf{C}$  and  $a, b \in \mathcal{A}$ .

The norm is subject to the following axioms:

- (5) the axioms of a normed space;
- (6)  $\mathcal{A}$  is complete (that is, a Banach space);
- (7)  $\|ab\| \leq \|a\| \|b\|$  for all  $a, b \in \mathcal{A}$ ;
- (8)  $\|a^*a\| = \|a\|^2$  for all  $a \in \mathcal{A}$ .

A unital  $C^*$ -algebra is a  $C^*$ -algebra  $\mathcal{A}$  which has an element  $e$  such that  $ae = ea = a$  for all  $a \in \mathcal{A}$ . A  $C^*$ -algebra  $\mathcal{A}$  is said to be commutative if  $ab = ba$  for all  $a, b \in \mathcal{A}$ .



If  $H$  a Hilbert space, then  $\mathcal{B}(H)$ , the set of all bounded linear operators on  $H$ , and  $\mathcal{K}(H)$ , the collection of all compact linear operators on  $H$ , are  $C^*$ -algebras with the usual algebraic operations, with the operator norm,

$$\|A\| = \sup_{x \neq 0} \frac{\|Ax\|}{\|x\|},$$

and with passage to the adjoint operator as involution. The set  $L^\infty$  is a  $C^*$ -algebra under pointwise algebraic operations, the  $\|\cdot\|_\infty$  norm, and the involution  $a \mapsto \bar{a}$  (passage to the complex conjugate). The  $C^*$ -algebra  $L^\infty$  is commutative, the  $C^*$ -algebras  $\mathcal{B}(H)$  and  $\mathcal{K}(H)$  are not commutative for  $\dim H \geq 2$ . The  $C^*$ -algebra  $\mathcal{K}(H)$  is unital if and only if  $\dim H < \infty$ , in which case  $\mathcal{K}(H) = \mathcal{B}(H)$ .

An element  $a$  of a unital  $C^*$ -algebra  $\mathcal{A}$  is said to be *invertible* if there is a  $b \in \mathcal{A}$  such that  $ab = ba = e$ . If it exists, this element  $b$  is unique; it is denoted by  $a^{-1}$  and called the *inverse* of  $A$ . The *spectrum* of an element  $A$  of a unital  $C^*$ -algebra  $\mathcal{A}$  is the compact and nonempty set

$$\text{sp}_{\mathcal{A}} a := \{\lambda \in \mathbf{C} : a - \lambda e \text{ is not invertible in } \mathcal{A}\}.$$

A subset  $\mathcal{A}$  of a  $C^*$ -algebra  $\mathcal{B}$  is called a  $C^*$ -subalgebra of  $\mathcal{B}$  if  $\mathcal{A}$  itself is a  $C^*$ -algebra with the norm and the operations of  $\mathcal{B}$ . The following theorem says that  $C^*$ -algebras are “inverse closed”.

### Theorem

*If  $\mathcal{B}$  is a unital  $C^*$ -algebra with the unit element  $e$  and if  $\mathcal{A}$  is a  $C^*$ -subalgebra of  $\mathcal{B}$  which contains  $e$ , then  $\text{sp}_{\mathcal{A}} a = \text{sp}_{\mathcal{B}} a$  for every  $a \in \mathcal{A}$ .*

By virtue of this theorem, we will abbreviate  $\text{sp}_{\mathcal{A}} a$  to  $\text{sp } a$ .

A  $C^*$ -subalgebra  $\mathcal{J}$  of a  $C^*$ -algebra  $\mathcal{A}$  is called a *closed ideal* of  $\mathcal{A}$  if  $aj \in \mathcal{J}$  and  $ja \in \mathcal{J}$  for all  $a \in \mathcal{A}$  and all  $j \in \mathcal{J}$ .

## Theorem

If  $\mathcal{A}$  is a  $C^*$ -algebra and  $\mathcal{J}$  is a closed ideal of  $\mathcal{A}$ , then the quotient algebra  $\mathcal{A}/\mathcal{J}$  is a  $C^*$ -algebra with the usual quotient operations,

$$\lambda(a + \mathcal{J}) := \lambda a + \mathcal{J}, \quad (a + \mathcal{J}) + (b + \mathcal{J}) := (a + b) + \mathcal{J},$$

$$(a + \mathcal{J})(b + \mathcal{J}) := ab + \mathcal{J}, \quad (a + \mathcal{J})^* := a^* + \mathcal{J},$$

and the usual quotient norm,

$$\|a + \mathcal{J}\| := \inf_{j \in \mathcal{J}} \|a + j\|.$$

A  $*$ -homomorphism is a linear map  $\varphi : \mathcal{A} \rightarrow \mathcal{B}$  of a  $C^*$ -algebra  $\mathcal{A}$  to  $C^*$ -algebra  $\mathcal{B}$  which satisfies  $\varphi(a)^* = \varphi(a^*)$  and  $\varphi(ab) = \varphi(a)\varphi(b)$  for all  $a, b \in \mathcal{A}$ . In case  $\mathcal{A}$  and  $\mathcal{B}$  are unital, we also require that  $*$ -homomorphisms map the unit element of  $\mathcal{A}$  to the unit element of  $\mathcal{B}$ . Bijective  $*$ -homomorphisms are referred to as  $*$ -isomorphisms.

## Theorem

Let  $\mathcal{A}$  and  $\mathcal{B}$  be unital  $C^*$ -algebras and suppose that  $\varphi : \mathcal{A} \rightarrow \mathcal{B}$  is a  $*$ -homomorphism. Then the following hold.

- (a) The map  $\varphi$  is contractive:  $\|\varphi(a)\| \leq \|a\|$  for all  $a \in \mathcal{A}$ .
- (b) The image  $\varphi(\mathcal{A})$  is a  $C^*$ -subalgebra of  $\mathcal{B}$ .
- (c) If  $\varphi$  is injective, then  $\varphi$  preserves spectra and norms:  
 $\text{sp } \varphi(a) = \text{sp } a$  and  $\|\varphi(a)\| = \|a\|$  for all  $a \in \mathcal{A}$ .

## Fredholm Operators

Let  $H$  be a Hilbert space. An operator  $A \in \mathcal{B}(H)$  is said to be *Fredholm* if it is invertible modulo compact operators, that is, if the coset  $A + \mathcal{K}(H)$  is invertible in the quotient algebra  $\mathcal{B}(H)/\mathcal{K}(H)$ . It is well known that an operator  $A \in \mathcal{B}(H)$  is Fredholm if and only if it is *normally solvable* (which means that its range  $\text{Im } A$  is a closed subspace of  $H$ ) and both the *kernel*

$$\text{Ker } A := \{x \in H : Ax = 0\}$$

and the *cokernel*

$$\text{Coker } A := l^2/H$$

have finite dimensions. Thus, for a Fredholm operator  $A$ , the *index*

$$\text{Ind } A = \dim \text{Ker } A - \dim \text{Coker } A$$

is a well defined integer.

## Example

For  $n \in \mathbf{Z}$ , let  $\chi_n$  be the function given by  $\chi_n(t) = t^n$  ( $t \in \mathbf{T}$ ). It is readily seen that  $T(\chi_n)$  acts by the rule

$$T(\chi_n) : (x_j)_{j=0}^{\infty} \mapsto (\underbrace{0, \dots, 0}_n, x_0, x_1, \dots) \text{ if } n \geq 0,$$

$$T(\chi_n) : (x_j)_{j=0}^{\infty} \mapsto (x_{|n|}, x_{|n|+1}, \dots) \text{ if } n < 0.$$

Consequently,

$$\dim \text{Ker } T(\chi_n) = \begin{cases} 0 & \text{if } n \geq 0, \\ |n| & \text{if } n < 0, \end{cases} \quad \dim \text{Coker } T(\chi_n) = \begin{cases} n & \text{if } n \geq 0, \\ 0 & \text{if } n < 0, \end{cases}$$

whence  $\text{Ind } T(\chi_n) = -n$  for all  $n \in \mathbf{Z}$ . ■

The following theorem summarizes some well known properties of the index.

## Theorem

Let  $A, B \in \mathcal{B}(H)$  be Fredholm operators.

- (a) If  $K \in \mathcal{K}(H)$ , then  $A + K$  is Fredholm and  $\text{Ind}(A + K) = \text{Ind } A$ .
- (b) There is an  $\varepsilon = \varepsilon(A) > 0$  such that  $A + C$  is Fredholm and  $\text{Ind}(A + C) = \text{Ind } A$  whenever  $C \in \mathcal{B}(H)$  and  $\|C - A\| < \varepsilon$ .
- (c) The product  $AB$  is Fredholm and  $\text{Ind}(AB) = \text{Ind } A + \text{Ind } B$ .
- (d) The adjoint operator  $A^*$  is Fredholm and  $\text{Ind } A^* = -\text{Ind } A$ .

The spectrum of an operator  $A \in \mathcal{B}(H)$  is its spectrum  $\text{sp } A$  as an element of the  $C^*$ -algebra  $\mathcal{B}(H)$ :

$$\text{sp } A := \{\lambda \in \mathbf{C} : A - \lambda I \text{ is not invertible}\}.$$

By last Theorem, the quotient algebra  $\mathcal{B}(H)/\mathcal{K}(H)$  is also a  $C^*$ -algebra. For  $A$  in  $\mathcal{B}(H)$ , the *essential spectrum*  $\text{sp}_{\text{ess}} A$  is defined as the spectrum of  $A + \mathcal{K}(H)$  in  $\mathcal{B}(H)/\mathcal{K}(H)$ ,

$$\text{sp}_{\text{ess}} A := \text{sp}(A + \mathcal{K}(H)) = \{\lambda \in \mathbf{C} : A - \lambda I \text{ is not Fredholm}\},$$

and the *essential norm*  $\|A\|_{\text{ess}}$  is defined as the norm of  $A + \mathcal{K}(H)$  in  $\mathcal{B}(H)/\mathcal{K}(H)$ ,

$$\|A\|_{\text{ess}} = \|A + \mathcal{K}(H)\| = \inf_{K \in \mathcal{K}(H)} \|A + K\|.$$

Obviously,

$$\text{sp}_{\text{ess}} A \subset \text{sp} A, \quad \|A\|_{\text{ess}} \leq \|A\|.$$



## Continuous Symbols

We will mainly be concerned with Toeplitz operators with continuous symbols. Let  $C = C(\mathbf{T})$  be the set of all (complex-valued) continuous functions on  $\mathbf{T}$ . Clearly,  $C$  is a  $C^*$ -subalgebra of  $L^\infty$ .

We give  $\mathbf{T}$  the counter-clockwise orientation. For a function  $a \in C$ , the image  $a(\mathbf{T})$  is a closed continuous and naturally oriented curve in the complex plane. If a point  $\lambda \in \mathbf{C}$  is not located on  $a(\mathbf{T})$ , we denote by  $\text{wind}(a, \lambda)$  the winding number of the curve  $a(\mathbf{T})$  with respect to  $\lambda$ .

### Theorem (Gohberg 1952)

*Let  $a \in C$ . The operator  $T(a)$  is Fredholm if and only if  $0 \notin a(\mathbf{T})$ . In that case*

$$\text{Ind } T(a) = -\text{wind}(a, 0).$$

The proof of this theorem is based on two auxiliary results.

For  $a \in L^\infty$ , we define the function  $\tilde{a} \in L^\infty$  by  $\tilde{a}(t) := a(1/t)$  ( $t \in \mathbf{T}$ ). In terms of Fourier series:

$$a(t) = \sum_{n=-\infty}^{\infty} a_n t^n \implies \tilde{a}(t) = \sum_{n=-\infty}^{\infty} a_{-n} t^n.$$

Clearly,

$$T(a) = \begin{pmatrix} a_0 & a_{-1} & a_{-2} & \dots \\ a_1 & a_0 & a_{-1} & \dots \\ a_2 & a_1 & a_0 & \dots \\ \dots & \dots & \dots & \dots \end{pmatrix}, \quad T(\tilde{a}) = \begin{pmatrix} a_0 & a_1 & a_2 & \dots \\ a_{-1} & a_0 & a_1 & \dots \\ a_{-2} & a_{-1} & a_0 & \dots \\ \dots & \dots & \dots & \dots \end{pmatrix}.$$

Thus,  $T(\tilde{a})$  is the transpose of  $T(a)$ . The *Hankel operator*  $H(a)$  generated by  $a$  is given by the matrix

$$H(a) = (a_{j+k+1})_{j,k=0}^{\infty} = \begin{pmatrix} a_1 & a_2 & a_3 & \dots \\ a_2 & a_3 & \dots & \\ a_3 & \dots & & \\ \dots & & & \end{pmatrix}.$$

Obviously,  $\tilde{a}$  generates the Hankel operator

$$H(\tilde{a}) = (a_{-j-k-1})_{j,k=0}^{\infty} = \begin{pmatrix} a_{-1} & a_{-2} & a_{-3} & \dots \\ a_{-2} & a_{-3} & \dots & \\ a_{-3} & \dots & & \\ \dots & & & \end{pmatrix}.$$

Because  $H(a)$  may be identified with the matrix in the lower left quarter of the matrix (3), we see that if  $a \in L^{\infty}$ , then  $H(a)$  induces a bounded operator on  $l^2$  and

$$\|H(a)\| \leq \|a\|_{\infty}. \quad (9)$$

Since  $\|a\|_{\infty} = \|\tilde{a}\|_{\infty}$ , we also have

$$\|H(\tilde{a})\| \leq \|a\|_{\infty}. \quad (10)$$

### Proposition

If  $a, b \in L^{\infty}$ , then

$$T(a)T(b) = T(ab) - H(a)H(\tilde{b}).$$

We omit the proof, because once this formula has been guessed, it can be easily verified by comparing the corresponding entries of each side.

### Proposition

If  $c \in C$ , then  $H(c)$  and  $H(\tilde{c})$  are compact operators on  $l^2$ .

*Proof.* Let  $\{f_n\}$  be a sequence of trigonometric polynomials such that

$$\|c - f_n\|_\infty \rightarrow 0$$

(for example, let  $f_n$  be the  $n$ th Fejér-Cèsaro mean of  $c$ ). From (9) and (10) we infer that

$$\|H(c) - H(f_n)\| \leq \|c - f_n\|_\infty = o(1),$$

$$\|H(\tilde{c}) - H(\tilde{f}_n)\| \leq \|c - f_n\|_\infty = o(1),$$

and as  $H(f_n)$  and  $H(\tilde{f}_n)$  are finite-rank operators, it follows that  $H(c)$  and  $H(\tilde{c})$  are compact. ■

*Proof of Gohberg Theorem.* Consider the map

$$\varphi : C \rightarrow \mathcal{B}(l^2)/\mathcal{K}(l^2), \quad a \mapsto T(a) + \mathcal{K}(l^2).$$

This map is obviously linear, we have

$$\varphi(a)^* = (T(a) + \mathcal{K}(l^2))^* = T(\bar{a}) + \mathcal{K}(l^2) = \varphi(\bar{a}),$$

above Propositions imply that

$$\begin{aligned} \varphi(a)\varphi(b) &= (T(a) + \mathcal{K}(l^2))(T(b) + \mathcal{K}(l^2)) \\ &= T(ab) + \mathcal{K}(l^2) = \varphi(ab). \end{aligned} \tag{11}$$

Thus,  $\varphi$  is a  $*$ -homomorphism. We know that  $\varphi$  is injective.

Consequently,  $\varphi$  is a  $*$ -isomorphism of  $C$  onto the  $C^*$ -subalgebra  $\varphi(C)$  of  $\mathcal{B}(l^2)/\mathcal{K}(l^2)$ . So we have that  $T(a)$  is Fredholm if and only if  $a$  is invertible in  $C$ , that is, if and only if  $0 \notin a(\mathbf{T})$ .

The index formula follows from a simple homotopy argument. Let  $\Phi(l^2)$  be the set of Fredholm operators on  $l^2$  and let  $GC$  be the set of all  $a \in C$  for which  $0 \notin a(\mathbf{T})$ . If  $a \in GC$  and  $\text{wind}(a, 0) = n$ , then there is a continuous function

$$[0, 1] \rightarrow GC, \quad \mu \mapsto a_\mu$$

such that  $a_0 = a$  and  $a_1 = \chi_n$  (recall Example 7). The function

$$[0, 1] \rightarrow \Phi(l^2), \quad \mu \mapsto T(a_\mu)$$

is also continuous, and Theorem about index stability shows that the map

$$[0, 1] \rightarrow \mathbf{Z}, \quad \mu \mapsto \text{Ind } T(a_\mu)$$

is continuous and locally constant. Thus, the last map is constant. This implies that

$$\text{Ind } T(a) = \text{Ind } T(a_0) = \text{Ind } T(a_1) = \text{Ind } T(\chi_n).$$

Example 7 finally tells us that  $\text{Ind } T(\chi_n) = -n$ . ■

## Theorem (Gohberg 1952)

Let  $a \in C$ . The operator  $T(a)$  is invertible if and only if it is Fredholm of index zero.

*Proof.* The “only if” part is trivial. To prove the “if” portion, suppose  $T(a)$  is Fredholm of index zero, and, contrary to what we want, let us assume that  $T(a)$  is not invertible. Then

$$\dim \operatorname{Ker} T(a) = \dim \operatorname{Coker} T(a) > 0,$$

and since

$$\dim \operatorname{Coker} T(a) = \dim \operatorname{Ker} T^*(a) = \dim \operatorname{Ker} T(\bar{a}),$$

there are nonzero  $x_+, y_+ \in l^2$  such that

$$T(a)x_+ = 0, \quad T(\bar{a})y_+ = 0.$$

Extend  $x_+$  and  $y_+$  by zero to all of  $\mathbf{Z}$  and let  $L(a)$  be the operator (3). Then

$$L(a)x_+ = x_- \text{ where } x_- \in l^2(\mathbf{Z}) \text{ and } (x_-)_n = 0 \text{ for } n \geq 0,$$

$$L(\bar{a})y_+ = y_- \text{ where } y_- \in l^2(\mathbf{Z}) \text{ and } (y_-)_n = 0 \text{ for } n \geq 0.$$

The convolution  $u * v$  of two sequences  $u, v \in l^2(\mathbf{Z})$  is the sequence  $\{(u * v)_n\}_{n=-\infty}^{\infty}$  given by

$$(u * v)_n = \sum_{k=-\infty}^{\infty} u_k v_{n-k}.$$

Note that  $u * v$  is a well defined sequence in  $l^\infty(\mathbf{Z})$ , because

$$|(u * v)_n| \leq \|u\|_2 \|v\|_2 < \infty,$$

where  $\|\cdot\|_2$  denotes the norm in  $l^2(\mathbf{Z})$ . Let  $b \in l^2(\mathbf{Z})$  be the sequence of the Fourier coefficients of  $a \in C \subset L^2$ . Given a sequence  $f = (f_n)_{n=-\infty}^{\infty}$ , we define the sequence  $f^\#$  by  $(f^\#)_n := \overline{f_{-n}}$ . It easily seen that  $(u * v)^\# = u^\# * v^\#$  for  $u, v \in l^2(\mathbf{Z})$ .



We have

$$\begin{aligned}L(a)x_+ &= b * x_+ = x_-, \\L(a)y_+ &= b^\# * y_+ = y_-.\end{aligned}$$

Hence,

$$y_-^\# * x_+ = (b^\# * y_+)^\# * x_+ = (b * y_+^\#) * x_+ = (y_+^\# * b) * x_+. \quad (12)$$

We claim that

$$(y_+^\# * b) * x_+ = y_+^\# * (b * x_+). \quad (13)$$

This is easily verified if  $y_+$  and  $x_+$  have finite supports. Because

$$|((y_+^\# * b) * x_+)_n| \leq \|y_+^\# * b\|_2 \|x_+\|_2 \leq \|y_+\|_2 \|a\|_\infty \|x_+\|_2,$$

$$|(y_+^\# * (b * x_+))_n| \leq \|y_+^\#\|_2 \|b * x_+\|_2 \leq \|y_+\|_2 \|a\|_\infty \|x_+\|_2,$$

it follows that (13) is true for arbitrary  $y_+, x_+ \in l^2(\mathbf{Z})$ . From (12) and (13) we get

$$y_-^\# * x_+ = y_+^\# * (b * x_+) = y_+^\# * x_-. \quad (14)$$

Since  $(y_-^\# * x_+)_n = 0$  for  $n \leq 0$  and  $(y_+^\# * x_-)_n = 0$  for  $n \geq 0$ , we see that (14) is the zero sequence. In particular,  $(y_+^\# * x_-)_n = 0$  for all  $n \geq 0$ , which means that

$$\begin{aligned} \overline{(y_+)_0}(x_-)_{-1} &= 0, \\ \overline{(y_+)_0}(x_-)_{-2} + \overline{(y_+)_1}(x_-)_{-1} &= 0, \\ \overline{(y_+)_0}(x_-)_{-3} + \overline{(y_+)_1}(x_-)_{-2} + \overline{(y_+)_2}(x_-)_{-1} &= 0, \\ \dots \dots \dots \end{aligned}$$

As  $y_+ \neq 0$ , it results that

$$(x_-)_{-1} = (x_-)_{-2} = (x_-)_{-3} = \dots = 0.$$

Hence  $x_- = 0$ . This implies that  $L(a)x_+ = 0$ . The Fredholmness of  $T(a)$  in conjunction with Theorem 9 shows that  $a$  has no zeros on  $\mathbf{T}$ .

Consequently,  $a^{-1} \in L^\infty$  and as  $L(a^{-1})$  and  $L(a)$  are unitarily equivalent to  $M(a^{-1})$  and  $M(a)$ , respectively, we obtain that  $L(a^{-1})$  is the inverse of  $L(a)$ . It follows that  $x_+ = 0$ , which is a contradiction. ■

In summary, we have proved the following. If  $a \in C$ , then

$$\|T(a)\| = \|T(a)\|_{\text{ess}} = \|a\|_{\infty}, \quad (15)$$

$$\text{sp}_{\text{ess}} T(a) = a(\mathbf{T}), \quad (16)$$

$$\text{sp} T(a) = a(\mathbf{T}) \cup \{\lambda \in \mathbf{C} \setminus a(\mathbf{T}) : \text{wind}(a, \lambda) \neq 0\}. \quad (17)$$

Moreover, if  $a \in C$  and  $0 \notin a(\mathbf{T})$ , the Propositions 10 and 11 give

$$T(a^{-1})T(a) = I - H(a^{-1})H(\tilde{a}) \in I + \mathcal{K}(l^2),$$

$$T(a)T(a^{-1}) = I - H(a)H(\tilde{a}^{-1}) \in I + \mathcal{K}(l^2).$$

Thus,  $T(a^{-1})$  is an inverse of  $T(a)$  modulo  $\mathcal{K}(l^2)$ . In particular,

$$\|T^{-1}(a)\|_{\text{ess}} = \|T(a^{-1})\|_{\text{ess}} \text{ and, hence,}$$

$$\|T^{-1}(a)\| \geq \|T^{-1}(a)\|_{\text{ess}} = \|T(a^{-1})\| = \|a^{-1}\|_{\infty}. \quad (18)$$

# $C^*$ -Algebras in Action

## Finite Section Method

Let  $\{A_n\}_{n=1}^{\infty}$  be a sequence of  $n \times n$  matrices  $A_n$ . This sequence is said to be *stable* if there is an  $n_0$  such that the matrices  $A_n$  are invertible for all  $n \geq n_0$  and

$$\sup_{n \geq n_0} \|A_n^{-1}\| < \infty.$$

Using the convention to put  $\|A^{-1}\| = \infty$  if  $A$  is not invertible, we can say that  $\{A_n\}_{n=1}^{\infty}$  is a stable sequence if and only if

$$\limsup_{n \rightarrow \infty} \|A_n^{-1}\| < \infty.$$

Stability plays a central role in asymptotic linear algebra and numerical analysis. At the present moment, we confine ourselves to the part stability plays in connection with the finite section method.

Let  $A \in \mathcal{B}(l^2)$  be a given operator and let  $\{A_n\}_{n=1}^\infty$  be a sequence of  $n \times n$  matrices. In order to solve the equation

$$Ax = y \quad (19)$$

one can have recourse to the finite systems

$$A_n x^{(n)} = P_n y, \quad x^{(n)} \in \text{Im } P_n, \quad (20)$$

where here and throughout what follows  $P_n$  is the projection

$$P_n : l^2 \rightarrow l^2, \quad (x_0, x_1, x_2, \dots) \mapsto (x_0, x_1, \dots, x_{n-1}, 0, 0, \dots). \quad (21)$$

The image  $\text{Im } P_n$  of  $P_n$  is a subspace of  $l^2$ , but we freely identify  $\text{Im } P_n$  with  $\mathbf{C}^n$ . This allows us to think of  $A_n$  and  $A_n^{-1}$  as operators on  $l^2$ : we can make the identifications  $A_n = A_n P_n$  and  $A_n^{-1} = A_n^{-1} P_n$ .

Suppose  $A$  is invertible. One says that *the method*  $\{A_n\}$  *is applicable to*  $A$  if there is an  $n_0$  such that the equation (20) are uniquely solvable for every  $y \in l^2$  and all  $n \geq n_0$  and if their solutions  $x^{(n)}$  converge in  $l^2$  to the solution  $x$  of (19) for every  $y \in l^2$ . Equivalently, the method  $\{A_n\}$  is applicable to  $A$  if and only if the matrices  $A_n$  are invertible for all sufficiently large  $n$  and  $A_n^{-1} \rightarrow A^{-1}$  strongly (i.e.,  $A_n^{-1}P_n y \rightarrow A^{-1}y$  for all  $y \in l^2$ ).

**In the case where  $A_n = P_n A P_n | \text{Im } P_n$ , one speaks of the finite section method.**

## Proposition

*Let  $A \in \mathcal{B}(l^2)$  be invertible and suppose  $\{A_n\}$  is a sequence of  $n \times n$  matrices such that  $A_n \rightarrow A$  strongly. Then the method  $\{A_n\}$  is applicable to  $A$  if and only if the sequence  $\{A_n\}$  is stable.*

*Proof.* If  $A_n^{-1} \rightarrow A^{-1}$  strongly, then  $\limsup \|A_n^{-1}\| < \infty$  due to the Banach-Steinhaus theorem (= uniform boundedness principle). Hence  $\{A_n\}$  is stable. Conversely, suppose  $\{A_n\}$  is stable. Then for each  $y \in l^2$ ,

$$\|A_n^{-1}P_n y - A^{-1}y\| \leq \|A_n^{-1}P_n y - P_n A^{-1}y\| + \|P_n A^{-1}y - A^{-1}y\|,$$

the second term on the right goes to zero because  $P_n \rightarrow I$  strongly, and the first term on the right is

$$\|A_n^{-1}(P_n y - A_n P_n A^{-1}y)\| \leq M \|P_n y - A_n P_n A^{-1}y\| = o(1)$$

since  $A_n P_n A^{-1} \rightarrow A A^{-1} = I$  strongly. ■



We remark that last Proposition can be stated as

convergence = approximation + stability;

here convergence means applicability of the method  $\{A_n\}$  to  $A$ , while approximation means that  $A_n \rightarrow A$  strongly. As approximation is usually given (e.g., if  $A_n = P_n A P_n | \text{Im } P_n$ ) or enforced by the choice of  $\{A_n\}$ , the central problem is always the stability.

The following simple fact will be needed later.

### Proposition (Invertibilites)

*Let  $\{A_n\}$  be a sequence of  $n \times n$  matrices and suppose there is an operator  $A \in \mathcal{B}(l^2)$  such that  $A_n \rightarrow A$  and  $A_n^* \rightarrow A^*$  strongly. If  $\{A_n\}$  is stable, then  $A$  is necessarily invertible and*

$$\|A^{-1}\| \leq \liminf_{n \rightarrow \infty} \|A_n^{-1}\|. \quad (22)$$

*Proof.* Suppose  $\|A_n^{-1}\| \leq M$  for infinitely many  $n$ . For  $x \in l^2$  and these  $n$ ,

$$\begin{aligned}\|P_n x\| &= \|A_n^{-1} A_n P_n x\| \leq M \|A_n P_n x\|, \\ \|P_n x\| &= \|(A_n^*)^{-1} A_n^* P_n x\| \leq M \|A_n^* P_n x\|.\end{aligned}$$

and passing to the limit  $n \rightarrow \infty$ , we get

$$\|x\| \leq M \|Ax\|, \quad \|x\| \leq M \|A^*x\|,$$

which implies that  $A$  is invertible and  $\|A^{-1}\| \leq M$ .

## Perturbed Toeplitz Matrices

For  $a \in L^\infty$ , let  $T_n(a)$  be the  $n \times n$  matrix

$$T_n(a) = \begin{pmatrix} a_0 & \dots & a_{-(n-1)} \\ \vdots & \ddots & \vdots \\ a_{n-1} & \dots & a_0 \end{pmatrix}.$$

We will freely identify the  $n \times n$  matrix  $T_n(a)$  with the operator  $P_n T(a) P_n |_{\text{Im } P_n}$  or even with  $P_n T(a) P_n$ . Obviously,

$$T_n(a) \rightarrow T(a), \quad T_n^*(a) = T_n(\bar{a}) \rightarrow T(\bar{a}) = T^*(a)$$

strongly. In particular, Proposition (Invertibilites) tells us that the finite section method  $\{T_n(a)\}$  is applicable to an invertible Toeplitz operator  $T(a)$  if and only if  $\{T_n(a)\}$  is stable.

Instead of the pure Toeplitz matrices  $T_n(a)$ , we will consider more general matrices, namely, matrices of the form

$$A_n = T_n(a) + P_n K P_n + W_n L W_n + C_n; \quad (23)$$

here  $a \in L^\infty$ ,  $K \in \mathcal{K}(l^2)$ ,  $L \in \mathcal{K}(l^2)$ ,  $\{C_n\}$  is a sequence of  $n \times n$  matrices such that  $\|C_n\| \rightarrow 0$ ,  $P_n$  is given by (21), and  $W_n$  is defined as

$$W_n : l^2 \rightarrow l^2, \quad (x_0, x_1, x_2, \dots) \mapsto (x_{n-1}, x_{n-2}, \dots, x_0, 0, 0, \dots).$$

Again we freely identify  $\text{Im } W_n \subset l^2$  and  $\mathbf{C}^n$ , and frequently we think of  $W_n$  as being the matrix

$$W_n = \begin{pmatrix} 0 & \dots & 0 & 1 \\ 0 & \dots & 1 & 0 \\ \vdots & & \vdots & \vdots \\ 1 & \dots & 0 & 0 \end{pmatrix}.$$

There are several good reasons for studying sequences  $\{A_n\}$  with  $A_n$  of the form (23). First, the matrices one encounters in applications are often not pure Toeplitz matrices but perturbed Toeplitz matrices. For example, if  $K$  and  $L$  have only finitely many nonzero entries, then  $T_n(a) + P_n K P_n + W_n L W_n$  results from  $T_n(a)$  by adding the block  $K$  in the upper left and the “reverse” of the block  $L$  in the lower right corner. Note that, for instance,

$$W_n \begin{pmatrix} 3 & 7 & 0 & \dots & 0 \\ 5 & 2 & 0 & \dots & 0 \\ 0 & 0 & 0 & \dots & 0 \\ \vdots & \vdots & \vdots & & \vdots \\ 0 & 0 & 0 & \dots & 0 \end{pmatrix} W_n = \begin{pmatrix} 0 & \dots & 0 & 0 & 0 \\ \vdots & & \vdots & \vdots & \vdots \\ 0 & \dots & 0 & 0 & 0 \\ 0 & \dots & 0 & 2 & 5 \\ 0 & \dots & 0 & 7 & 3 \end{pmatrix}.$$

Secondly, consideration of matrices of the form (23) is motivated by the following result.

## Proposition (Widom 1976)

If  $a, b \in L^\infty$ , then

$$T_n(a)T_n(b) = T_n(ab) - P_n H(a) H(\tilde{b}) P_n - W_n H(\tilde{a}) H(b) W_n.$$

The proof is a straightforward computation (once the formula has been guessed) and is therefore omitted.

If  $a, b \in C$ , then

$$T_n(a)T_n(b) = T_n(ab) + P_n K P_n + W_n L W_n$$

with compact operators  $K$  and  $L$ .

Finally and most importantly, we will see that the sequences  $\{A_n\}$  defined by matrices of the form (23) with  $a \in C$  constitute a  $C^*$ -algebra.

# Algebraization of Stability

Let  $\mathbf{S}$  be the set of all sequences  $\{A_n\} := \{A_n\}_{n=1}^{\infty}$  of  $n \times n$  matrices  $A_n$  such that

$$\sup_{n \geq 1} \|A_n\| < \infty,$$

and let  $\mathbf{N}$  (the  $\mathbf{N}$  is for "null") denote the set of all sequences  $\{A_n\}$  in  $\mathbf{S}$  for which

$$\lim_{n \rightarrow \infty} \|A_n\| = 0.$$

It is easily seen that  $\mathbf{S}$  is a  $C^*$ -algebra with the operations

$$\lambda\{A_n\} := \{\lambda A_n\}, \quad \{A_n\} + \{B_n\} := \{A_n + B_n\},$$

$$\{A_n\}\{B_n\} := \{A_n B_n\}, \quad \{A_n\}^* = \{A_n^*\}$$

and the norm

$$\|\{A_n\}\| := \sup_{n \geq 1} \|A_n\|$$

and that  $\mathbf{N}$  is a closed ideal of  $\mathbf{S}$ . Thus, the quotient algebra  $\mathbf{S}/\mathbf{N}$  is also a  $C^*$ -algebra. For  $\{A_n\} \in \mathbf{S}$ , we abbreviate the coset  $\{A_n\} + \mathbf{N}$  to  $\{A_n\}^\nu$ .

Obviously,

$$\|\{A_n\}^\nu\| = \limsup_{n \rightarrow \infty} \|A_n\|.$$

### Proposition

A sequence  $\{A_n\} \in \mathbf{S}$  is stable if and only if  $\{A_n\}^\nu$  is invertible in  $\mathbf{S}/\mathbf{N}$ .

*Proof.* If  $\{A_n\}$  is stable, there is a sequence  $\{B_n\} \in \mathbf{S}$  such that

$$B_n A_n = P_n + C'_n, \quad A_n B_n = P_n + C''_n, \quad (24)$$

where  $C'_n = C''_n = 0$  for all  $n \geq n_0$ . This implies that  $\{B_n\}^\nu$  is the inverse of  $\{A_n\}^\nu$ .

On the other hand, if  $\{A_n\}^\nu$  has the inverse  $\{B_n\}^\nu$  in  $\mathbf{S}/\mathbf{N}$ , then (24) holds with certain  $\{C'_n\} \in \mathbf{N}$  and  $\{C''_n\} \in \mathbf{N}$ . Clearly,  $\|C'_n\| < 1/2$  for all sufficiently large  $n$ . For these  $n$ , the matrix  $(P_n + C'_n)|_{\text{Im } P_n} = I + C'_n$  is invertible, whence

$$\|A_n^{-1}\| = \|(I + C'_n)^{-1} B_n\| \leq 2\|B_n\|,$$

which shows that  $\{A_n\}$  is stable. ■



The  $C^*$ -algebra  $\mathbf{S}/\mathbf{N}$  is very large and therefore difficult to understand. In order to study Toeplitz operators with continuous symbols, we can bound ourselves to a much smaller algebra. We define  $\mathbf{S}(C)$  as the subset of  $\mathbf{S}$  which consists of all elements  $\{A_n\}$  with

$$A_n = T_n(a) + P_n K P_n + W_n L W_n + C_n,$$

where  $a \in C$ ,  $K \in \mathcal{K}(l^2)$ ,  $L \in \mathcal{K}(l^2)$ ,  $\{C_n\} \in \mathbf{N}$ , and we let  $\mathbf{S}(C)/\mathbf{N}$  stand for the subset of  $\mathbf{S}/\mathbf{N}$  consisting of the coset  $\{A_n\}^\nu$  with  $\{A_n\}$  in  $\mathbf{S}(C)$ .

### Proposition

If  $\{A_n\} = \{T_n(a) + P_n K P_n + W_n L W_n + C_n\}$  is a sequence in  $\mathbf{S}(C)$ , then

$$A_n \rightarrow A := T(a) + K \quad \text{strongly} \quad (25)$$

and

$$W_n A_n W_n \rightarrow \tilde{A} := T(\tilde{a}) + L \quad \text{strongly.} \quad (26)$$

*Proof.* Since  $W_n \rightarrow 0$  weakly (that is,  $(W_n x, y) \rightarrow 0$  for all  $x, y$  in  $l^2$ ) and  $L$  is compact, it follows that  $LW_n \rightarrow 0$  strongly. As  $\|W_n\| = 1$ , we see that  $W_n L W_n \rightarrow 0$  strongly. This implies (25). Because

$$W_n A_n W_n = T_n(\tilde{a}) + W_n K W_n + P_n L P_n + W_n C_n W_n$$

and  $\|W_n\| = 1$ , (26) is a consequence of (25). ■

### Theorem (Silbermann 1981)

*The spaces  $\mathbf{S}(C)$  and  $\mathbf{S}(C)/\mathbf{N}$  are  $C^*$ -subalgebras of  $\mathbf{S}$  and  $\mathbf{S}/\mathbf{N}$ , respectively.*

*Proof.* As the quotient map  $\mathbf{S} \rightarrow \mathbf{S}/\mathbf{N}$  is clearly a (continuous)  $*$ -homomorphism and  $\mathbf{S}(C)$  is the pre-image of  $\mathbf{S}(C)/\mathbf{N}$ , it suffices to show that  $\mathbf{S}(C)/\mathbf{N}$  is a  $C^*$ -algebra of  $\mathbf{S}/\mathbf{N}$ .

We first show that  $\mathbf{S}(C)/\mathbf{N}$  is closed. So let

$$\{A_n^i\}^\nu = \{T_n(a_i) + P_n K_i P_n + W_n L_i W_n\}^\nu \quad (i = 1, 2, \dots)$$

be a Cauchy sequence in  $\mathbf{S}(C)/\mathbf{N}$ . Then, given  $\varepsilon > 0$ , there is an  $l = l(\varepsilon) > 0$  such that

$$\|\{A_n^i\}^\nu - \{A_n^j\}^\nu\| < \varepsilon \quad \text{for all } i, j \geq l.$$

From (25) we obtain that

$$\begin{aligned} \|T(a_i) + K_i - T(a_j) - K_j\| &\leq \liminf_{n \rightarrow \infty} \|A_n^i - A_n^j\| \\ &\leq \limsup_{n \rightarrow \infty} \|A_n^i - A_n^j\| = \|\{A_n^i\}^\nu - \{A_n^j\}^\nu\| < \varepsilon. \end{aligned}$$

This shows that  $\{T(a_i) + K_i\}_{i=1}^\infty$  is a Cauchy sequence. By (15)

$$\|a_i - a_j\|_\infty = \|T(a_i - a_j)\|_{\text{ess}} \leq \|T(a_i) - T(a_j) + K_i - K_j\|,$$

and hence  $\{a_i\}_{i=1}^\infty$  is a Cauchy sequence. It follows that  $a_i$  converges in  $L^\infty$  to some  $a \in L^\infty$ . Since  $\{T(a_i) + K_i\}_{i=1}^\infty$  is a Cauchy sequence, we now see that  $\{K_i\}_{i=1}^\infty$  is also a Cauchy sequence. Hence, there is a  $K \in \mathcal{K}(l^2)$  such that  $K_i \rightarrow K$  uniformly.

Now consider  $\{W_n A_n^i W_n\}$ . Since  $\|W_n\| = 1$ , we have

$$\|\{W_n A_n^i W_n\}^\nu - \{W_n A_n^j W_n\}^\nu\| \leq \|\{A_n^i\}^\nu - \{A_n^j\}^\nu\| < \varepsilon$$

for all  $i, j \geq l$ . This shows that  $\{W_n A_n^i W_n\}^\nu$  is Cauchy sequence. Using (26) instead of (25), we obtain as above that  $L_i$  converges uniformly to some  $L \in \mathcal{K}(I^2)$ . In summary,

$$\{A_n^i\}^\nu \rightarrow \{T_n(a) + P_n K P_n + W_n L W_n\}^\nu \quad \text{as } n \rightarrow \infty.$$

This completes the proof of the closedness of  $\mathbf{S}(C)/\mathbf{N}$ .

It is clear that  $\mathbf{S}(C)/\mathbf{N}$  is invariant under the two linear operations and the involution. It remains to show that the product of two elements of  $\mathbf{S}(C)/\mathbf{N}$  is again in  $\mathbf{S}(C)/\mathbf{N}$ . From Propositions above we infer that if  $a, b \in C$ , then

$$\{T_n(a)\}^\nu \{T_n(b)\}^\nu \in \mathbf{S}(C)/\mathbf{N}.$$

Now let  $a \in C$  and  $K \in \mathcal{K}(l^2)$ . Then

$$\begin{aligned} \{T_n(a)\}^\nu \{P_n K P_n\}^\nu &= \{P_n T(a) P_n K P_n\}^\nu \\ &= \{P_n T(a) K P_n\}^\nu - \{P_n T(a) Q_n K P_n\}^\nu, \end{aligned}$$

where  $Q_n = I - P_n$  (recall (8)). Obviously,  $T(a)K \in \mathcal{K}(l^2)$ . Since  $Q_n = Q_n^* \rightarrow 0$  strongly, it follows that  $Q_n K \rightarrow 0$  uniformly, whence  $\{P_n T(a) Q_n K P_n\} \in \mathbf{N}$ . Thus,

$$\{T_n(a)\}^\nu \{P_n K P_n\}^\nu = \{P_n T(a) K P_n\}^\nu \in \mathbf{S}(C)/\mathbf{N}.$$

If  $a \in C$  and  $L \in \mathcal{K}(l^2)$ , we have

$$\begin{aligned} \{T_n(a)\}^\nu \{W_n L W_n\}^\nu &= \{P_n T(a) W_n L W_n\}^\nu \\ &= \{W_n W_n T(a) W_n L W_n\}^\nu = \{W_n T(\tilde{a}) P_n L W_n\}^\nu \\ &= \{W_n T(\tilde{a}) L W_n\}^\nu - \{W_n T(\tilde{a}) Q_n L W_n\}^\nu, \end{aligned}$$

and it results as above that  $\{W_n T(\tilde{a}) Q_n L W_n\}^\nu \in \mathbf{N}$ , whence

$$\{T_n(a)\}^\nu \{W_n L W_n\}^\nu = \{W_n T(\tilde{a}) L W_n\}^\nu \in \mathbf{S}(C)/\mathbf{N}.$$

The remaining cases can be checked similarly. ■

## Corollary

A sequence  $\{A_n\} \in \mathbf{S}(C)$  is stable if and only if  $\{A_n\}^\nu$  is invertible in  $\mathbf{S}(C)/\mathbf{N}$ .

*Proof.* This is an immediate consequence of Silbermann Theorem. ■

Thus, for the sequences  $\{A_n\}$  we are interested in we have reduced the stability problem to an invertibility problem in the  $C^*$ -algebra  $\mathbf{S}(C)/\mathbf{N}$ .

## Stability Criteria

We now begin with the harvest from this Theory.

For  $\{A_n\} \in \mathbf{S}(C)$ , let  $A$  and  $\tilde{A}$  be as in (25)-(26). It is clear that the maps

$$\psi_0 : \mathbf{S}(C)/\mathbf{N} \rightarrow \mathcal{B}(l^2), \quad \{A_n\}^\nu \mapsto A,$$

$$\psi_1 : \mathbf{S}(C)/\mathbf{N} \rightarrow \mathcal{B}(l^2), \quad \{A_n\}^\nu \mapsto \tilde{A}$$

are well defined  $*$ -homomorphisms.

### Theorem (Silbermann 1981)

*A sequence  $\{A_n\}$  in the algebra  $\mathbf{S}(C)$  is stable if and only if the two operators  $A$  and  $\tilde{A}$  are invertible.*



*Proof.* Consider the  $*$ -homomorphism

$$\psi = \psi_0 \oplus \psi_1 : \mathbf{S}(C)/\mathbf{N} \rightarrow \mathcal{B}(l^2) \oplus \mathcal{B}(l^2), \quad \{A_n\}^\nu \mapsto (A, \tilde{A}). \quad (27)$$

Note that  $\mathcal{B}(l^2) \oplus \mathcal{B}(l^2)$  stands for the  $C^*$ -algebra of all ordered pairs  $(A, B)$  ( $A, B \in \mathcal{B}(l^2)$ ) with componentwise operations and the norm

$$\|(A, B)\| = \max(\|A\|, \|B\|).$$

We claim that  $\psi$  is injective. Indeed, if

$$A = T(a) + K = 0, \quad \tilde{A} = T(\tilde{a}) + L = 0,$$

then  $a = 0$  and hence  $K = L = 0$ , which implies that  $\{A_n\}^\nu = 0$ . We now deduce that  $\psi$  preserves spectra:  $\{A_n\}^\nu$  is invertible if and only if  $A$  and  $\tilde{A}$  are invertible. As the invertibility of  $\{A_n\}^\nu$  is equivalent to the stability of  $\{A_n\}$ , we arrive at the assertion. ■

## Corollary (Baxter 1963)

*Let  $a \in C$ . The sequence  $\{T_n(a)\}$  is stable if and only if  $T(a)$  is invertible.*

*Proof.* Since  $\tilde{A} = T(\tilde{a})$  is the transpose of  $A = T(a)$  and thus invertible if and only if  $A = T(a)$  is invertible, this corollary is an immediate consequence of Theorem Silbermann. ■

## Corollary

*The finite section method is applicable to every invertible Toeplitz operator with a continuous symbol.*

## Asymptotic Inverses

The following result reveals the structure of the inverse of matrices of the form (23) for large  $n$ .

### Theorem (Widom 1976 and Silbermann 1981)

Let

$$\{A_n\} = \{T_n(a) + P_n K P_n + W_n L W_n + C_n\} \in \mathbf{S}(C)$$

and suppose  $T(a) + K$  and  $T(\tilde{a}) + L$  are invertible. Then for all sufficiently large  $n$ ,

$$A_n^{-1} = T_n(a^{-1}) + P_n X P_n + W_n Y W_n + D_n, \quad (28)$$

where  $\|D_n\| \rightarrow 0$  as  $n \rightarrow \infty$  and the compact operators  $X$  and  $Y$  are given by

$$X = (T(a) + K)^{-1} - T(a^{-1}), \quad Y = (T(\tilde{a}) + L)^{-1} - T(\tilde{a}^{-1}).$$

*Proof.* If  $T(a) + K$  and  $T(\tilde{a}) + L$  are invertible, then  $\{A_n\}^\nu$  is invertible in  $\mathbf{S}(C)/\mathbf{N}$  by virtue of stability Criteria. Hence,  $A_n^{-1}$  is of the form

$$A_n^{-1} = T_n(b) + P_n X P_n + W_n Y W_n + D_n \quad (29)$$

with  $b \in C$ ,  $X \in \mathcal{K}(I^2)$ ,  $Y \in \mathcal{K}(I^2)$ ,  $\{D_n\} \in \mathbf{N}$ . Rewriting (29) in the form

$$\begin{aligned} P_n &= A_n(T_n(b) + P_n X P_n + W_n Y W_n + D_n), \\ P_n &= W_n A_n W_n (T_n(\tilde{b}) + W_n X W_n + P_n Y P_n + W_n D_n W_n). \end{aligned}$$

We obtain

$$I = (T(a) + K)(T(b) + X), \quad I = (T(\tilde{a}) + L)(T(\tilde{b}) + Y),$$

whence

$$X = (T(a) + K)^{-1} - T(b), \quad Y = (T(\tilde{a}) + L)^{-1} - T(\tilde{b}).$$

Finally, we deduce that

$$I = T(a)T(b) + KT(b) + T(a)X + KX = T(ab) + \text{compact operator},$$

and we have that  $ab = 1$ . ■

# Norms

In what follows we let  $A$  and  $\tilde{A}$  always stand for the two operators given by (25) and (26).

## Theorem

If  $\{A_n\} \in \mathbf{S}(C)$ , then

$$\lim_{n \rightarrow \infty} \|A_n\| = \max(\|A\|, \|\tilde{A}\|).$$

*Proof.* We observed that the  $*$ -homomorphism (27) is injective. From Theorem about  $*$ -homomorphism we therefore deduce that

$$\max(\|A\|, \|\tilde{A}\|) = \|\psi(\{A_n\}^\nu)\| = \|\{A_n\}^\nu\| = \limsup_{n \rightarrow \infty} \|A_n\|.$$

On the other hand, we know that

$$\|A\| \leq \liminf_{n \rightarrow \infty} \|A_n\|, \quad \|\tilde{A}\| \leq \liminf_{n \rightarrow \infty} \|A_n\|$$

(note that  $\|W_n A_n W_n\| = \|A_n\|$ ). ■

We remark that if  $A_n = T_n(a)$ , then  $\tilde{A} = T(\tilde{a})$  is the transpose of  $A = T(a)$ , so that  $\|T(\tilde{a})\| = \|T(a)\|$ . Thus in this case last Theorem yields the equality

$$\lim_{n \rightarrow \infty} \|T_n(a)\| = \|T(a)\|, \quad (30)$$

which can, of course, also easily be shown directly (and even for every  $a \in L^\infty$ ).

## Norms of Inverses

A simple  $C^*$ -algebra argument gives the following result.

### Theorem

If  $\{A_n\} \in \mathbf{S}(C)$ , then

$$\lim_{n \rightarrow \infty} \|A_n^{-1}\| = \max(\|A^{-1}\|, \|\tilde{A}^{-1}\|).$$



*Proof.* Suppose first that  $\|A^{-1}\| = \infty$  or  $\|\tilde{A}^{-1}\| = \infty$ . If

$$\liminf_{n \rightarrow \infty} \|A_n^{-1}\| < \infty, \quad (31)$$

then  $\{A_n\}$  contains a stable subsequence  $\{A_{n_k}\}$ , and it is clear that  $\{W_{n_k} A_{n_k} W_{n_k}\}$  is also stable. So we have that  $\|A^{-1}\| < \infty$  and  $\|\tilde{A}^{-1}\| < \infty$ . Thus, (31) cannot hold and we have indeed  $\lim \|A_n^{-1}\| = \infty$ .

Now suppose that  $A$  and  $\tilde{A}$  are invertible. Then  $\{A_n\}$  is stable and hence  $\{A_n\}^\nu$  is invertible in  $\mathbf{S}(C)/\mathbf{N}$ . Let  $\{B_n\}^\nu \in \mathbf{S}(C)/\mathbf{N}$  be the inverse. Then

$$\lim_{n \rightarrow \infty} \|B_n\| = \max(\|B\|, \|\tilde{B}\|),$$

and as  $A_n B_n \rightarrow I$  uniformly as  $n \rightarrow \infty$ , we see that

$$\lim_{n \rightarrow \infty} \|B_n\| = \lim_{n \rightarrow \infty} \|A_n^{-1}\|, \quad B = A^{-1}, \quad \tilde{B} = \tilde{A}^{-1}. \blacksquare$$

## Corollary

If  $a \in C$ , then

$$\lim_{n \rightarrow \infty} \|T_n^{-1}(a)\| = \|T^{-1}(a)\|.$$

*Proof.* Because  $\tilde{A} = T(\tilde{a})$  is the transpose of  $A = T(a)$ , this is immediate from last Theorem. ■

## Condition Numbers

The (spectral) *condition number*  $\kappa(B)$  of an operator is defined by

$$\kappa(B) = \|B\| \|B^{-1}\|.$$

### Theorem

If  $\{A_n\} \in \mathbf{S}(C)$ , then

$$\lim_{n \rightarrow \infty} \kappa(A_n) = \max(\|A\|, \|\tilde{A}\|) \max(\|A^{-1}\|, \|\tilde{A}^{-1}\|). \blacksquare \quad (32)$$

From (30) and last Corollary we infer that

$$\lim_{n \rightarrow \infty} \kappa(T_n(a)) = \kappa(T(a))$$

for every  $a \in C$ . However, for  $\{A_n\} \in \mathbf{S}(C)$ , the right-hand side of (32) may be larger than  $\max(\kappa(A), \kappa(\tilde{A}))$  and thus in general larger than  $\kappa(A)$ .

## Example

Let  $A_n = P_n + P_n K P_n + W_n L W_n$  with

$$K = \text{diag} \left( 0, -\frac{3}{4}, 0, 0, \dots \right), \quad L = \text{diag} \left( 2, -\frac{1}{2}, 0, 0, \dots \right).$$

Thus,

$$A_n = \text{diag} \left( 1, \frac{1}{4}, \underbrace{1, \dots, 1}_{n-4}, \frac{1}{2}, 3 \right).$$

It follows that

$$\begin{aligned} \|A_n\| &= 3, & \|A_n^{-1}\| &= 4, \\ \|A\| &= \|I + K\| = 1, & \|A^{-1}\| &= \|(I + K)^{-1}\| = 4, \\ \|\tilde{A}\| &= \|I + L\| = 3, & \|\tilde{A}^{-1}\| &= \|(I + L)^{-1}\| = 2, \end{aligned}$$

whence

$$\lim \kappa(A_n) = 12, \quad \max(\kappa(A), \kappa(\tilde{A})) = 6, \quad \kappa(A) = 4. \blacksquare$$

## Eigenvalues of Hermitian Matrices

Let  $\{E_n\}_{n=1}^{\infty}$  be a sequence of sets  $E_n \subset \mathbf{C}$ . The *uniform limiting set*

$$\liminf_{n \rightarrow \infty} E_n$$

is defined as the set of all numbers  $\lambda \in \mathbf{C}$  for which there are  $\lambda_1 \in E_1$ ,  $\lambda_2 \in E_2$ ,  $\lambda_3 \in E_3$ ,  $\dots$  such that  $\lambda_n \rightarrow \lambda$ , and the *partial limiting set*

$$\limsup_{n \rightarrow \infty} E_n$$

is the set of all  $\lambda \in \mathbf{C}$  for which there are  $\lambda_{n_1} \in E_{n_1}$ ,  $\lambda_{n_2} \in E_{n_2}$ ,  $\lambda_{n_3} \in E_{n_3}$ ,  $\dots$  such that  $n_k \rightarrow \infty$  and  $\lambda_{n_k} \rightarrow \lambda$ . For example, if  $E_n = \{0\}$  for odd  $n$  and  $E_n = \{1\}$  for even  $n$ , then  $\liminf E_n = \emptyset$  and  $\limsup E_n = \{0, 1\}$ .

Clearly, we always have

$$\liminf_{n \rightarrow \infty} E_n \subset \limsup_{n \rightarrow \infty} E_n.$$

## Theorem

If  $\{A_n\} \subset \mathbf{S}(C)$ , then

$$\liminf_{n \rightarrow \infty} \operatorname{sp} A_n \subset \limsup_{n \rightarrow \infty} \operatorname{sp} A_n \subset \operatorname{sp} A \cup \operatorname{sp} \tilde{A}, \quad (33)$$

and if  $\{A_n\} \in \mathbf{S}(C)$  is a sequence of Hermitian matrices,  $A_n = A_n^*$ , then

$$\liminf_{n \rightarrow \infty} \operatorname{sp} A_n = \limsup_{n \rightarrow \infty} \operatorname{sp} A_n = \operatorname{sp} A \cup \operatorname{sp} \tilde{A}. \quad (34)$$

*Proof.* Let  $\lambda \notin \text{sp } A \cup \text{sp } \tilde{A}$ . Then  $A - \lambda I$  and  $(A - \lambda I)^\sim = \tilde{A} - \lambda I$  are stability Criteria implies that there are  $n_0$  and  $M < \infty$  such that

$$\|(A_n - \lambda I)^{-1}\| \leq M \quad \text{for all } n \geq n_0.$$

It follows that the spectral radius of  $(A_n - \lambda I)^{-1}$  is at most  $M$ , which gives

$$U_{1/M}(0) \cap \text{sp } (A_n - \lambda I) = \emptyset \quad \text{for all } n \geq n_0,$$

where  $U_\delta(\mu) := \{\lambda \in \mathbf{C} : |\lambda - \mu| < \delta\}$ .



Consequently,

$$U_{1/M}(\lambda) \cap \operatorname{sp} A_n = \emptyset \quad \text{for all } n \geq n_0,$$

whence  $\lambda \notin \limsup A_n$ . This completes the proof of (33).

Now suppose  $A_n = A_n^*$  for all  $n$ . Then  $A$  and  $\tilde{A}$  are selfadjoint and all spectra occurring in (34) are subsets of the real line. We are left with showing that if  $\lambda \in \mathbf{R}$  and  $\lambda \notin \liminf \operatorname{sp} A_n$ , then  $\lambda \notin \operatorname{sp} A \cup \operatorname{sp} \tilde{A}$ . But if  $\lambda$  is real and not in the uniform limiting set of  $\operatorname{sp} A_n$ , then there exists a  $\delta > 0$  such that

$$U_\delta(\lambda) \cap \operatorname{sp} A_{n_k} = \emptyset \quad \text{for infinitely many } n_k,$$

that is,

$$U_\delta(0) \cap \operatorname{sp} (A_{n_k} - \lambda I) = \emptyset \quad \text{for infinitely many } n_k.$$

As  $A_{n_k} - \lambda I$  is Hermitian, the spectral radius and the norm of the operator  $(A_{n_k} - \lambda I)^{-1}$  coincide, which gives

$$\|(A_{n_k} - \lambda I)^{-1}\| \leq \frac{1}{\delta} \quad \text{for infinitely many } n_k.$$

It follows that  $\{A_{n_k} - \lambda I\}$  and thus also  $\{W_{n_k}(A_{n_k} - \lambda I)W_{n_k}\}$  is stable. So  $A - \lambda I$  and  $\tilde{A} - \lambda I$  are invertible. ■

## Corollary

If  $a \in C$ , then

$$\liminf_{n \rightarrow \infty} \operatorname{sp} T_n(a) \subset \limsup_{n \rightarrow \infty} \operatorname{sp} T_n(a) \subset \operatorname{sp} T(a),$$

and if  $a \in C$  is real-valued, then

$$\liminf_{n \rightarrow \infty} \operatorname{sp} T_n(a) = \limsup_{n \rightarrow \infty} \operatorname{sp} T_n(a) = \operatorname{sp} T(a) = [\min a, \max a].$$

*Proof.* From (17) we see that  $\operatorname{sp} T(\tilde{a}) = \operatorname{sp} T(a)$  for every  $A \in C$  and that  $\operatorname{sp} T(a)$  is the line segment  $[\min a, \max a]$  if  $a \in C$  is real-valued. ■

## Singular Values

The *singular values* of an operator  $B \in \mathcal{B}(H)$  on some Hilbert space  $H$  are the nonnegative square-roots of the numbers in the spectrum of the nonnegative operator  $B^*B$ . We denote the set of the singular values of  $B$  by  $\Sigma(B)$ . Thus,

$$\Sigma(B) = \{s \geq 0 : s^2 \in \text{sp}(B^*B)\}.$$

### Theorem

If  $\{A_n\} \in \mathbf{S}(C)$ , then

$$\liminf_{n \rightarrow \infty} \Sigma(A_n) = \limsup_{n \rightarrow \infty} \Sigma(A_n) = \Sigma(A) \cup \Sigma(\tilde{A}). \quad (35)$$

*Proof.* Since  $\{A_n^*A_n\} \in \mathbf{S}(C)$  whenever  $\{A_n\} \in \mathbf{S}(C)$ , (35) is a straightforward consequence of (34). ■

## Corollary

If  $a \in C$ , then

$$\liminf_{n \rightarrow \infty} \Sigma(T_n(a)) = \limsup_{n \rightarrow \infty} \Sigma(T_n(a)) = \Sigma(T(a)) \cup \Sigma(T(\tilde{a})). \blacksquare$$

Let  $V : l^2 \rightarrow l^2$  be the map given by  $(Vx)_j = \bar{x}_j$ . Since

$$\operatorname{sp} VBV = \operatorname{sp} B, \quad \operatorname{sp}(B^*B) \cup \{0\} = \operatorname{sp}(BB^*) \cup \{0\} \quad (36)$$

for every  $B \in \mathcal{B}(H)$  and because  $VT(a)V = T(\tilde{a})$ , we obtain

$$\begin{aligned} (\Sigma(T(\tilde{a})))^2 &= \operatorname{sp} T(a)T(\tilde{a}) = \operatorname{sp} VT(a)T(\tilde{a})V \\ &= \operatorname{sp} VT(a)VVT(\tilde{a})V = \operatorname{sp} T(\tilde{a})T(\tilde{a}) = (\Sigma(T(\tilde{a})))^2, \end{aligned}$$

that is,  $\Sigma(T(\tilde{a})) = \Sigma(T(\tilde{a}))$ . This and the second equality of (36) imply that

$$\Sigma(T(a)) \cup \{0\} = \Sigma(T(\tilde{a})) \cup \{0\}.$$

In general, the sets  $\Sigma(T(a))$  and  $\Sigma(T(\tilde{a}))$  need not coincide: if  $a(t) = t$ , then

$$T(a) = \begin{pmatrix} 0 & 0 & 0 & \dots \\ 1 & 0 & 0 & \dots \\ 0 & 1 & 0 & \dots \\ \dots & \dots & \dots & \dots \end{pmatrix}, \quad T(\tilde{a}) = \begin{pmatrix} 0 & 1 & 0 & \dots \\ 0 & 0 & 1 & \dots \\ 0 & 0 & 0 & \dots \\ \dots & \dots & \dots & \dots \end{pmatrix}$$

$$T^*(a)T(a) = \begin{pmatrix} 1 & 0 & 0 & \dots \\ 0 & 1 & 0 & \dots \\ 0 & 0 & 1 & \dots \\ \dots & \dots & \dots & \dots \end{pmatrix}, \quad T^*(\tilde{a})T(\tilde{a}) = \begin{pmatrix} 0 & 0 & 0 & \dots \\ 0 & 1 & 0 & \dots \\ 0 & 0 & 1 & \dots \\ \dots & \dots & \dots & \dots \end{pmatrix},$$

whence  $\Sigma(T(a)) = \{1\}$  and  $\Sigma(T(\tilde{a})) = \{0, 1\}$ .

The set  $\Sigma(T(a))$  is available in special cases only. Sometimes the following is useful.

## Proposition

If  $a \in C$ , then

$$[\min |a|, \max |a|] \subset \Sigma(T(a)) \subset [0, \max |a|].$$

*Proof.* There is a  $K \in \mathcal{K}(l^2)$  such that

$$\begin{aligned} (\Sigma(T(a)))^2 &= \text{sp } T(\bar{a})T(a) = \text{sp } (T(|a|^2) + K) \\ &\supset \text{sp}_{\text{ess}}(T(|a|^2) + K) = \text{sp}_{\text{ess}} T(|a|^2) = [\min |a|^2, \max |a|^2], \end{aligned}$$

and from (15) we get

$$(\Sigma(T(a)))^2 = \text{sp } T(\bar{a})T(a) \subset [0, \|T(a)\|^2] = [0, \max |a|^2]. \blacksquare$$

Thus if  $a \in C$  and  $T(a)$  is not Fredholm, which implies that  $\min |a| = 0$ , then

$$\Sigma(T(a)) \cup \Sigma(T(\tilde{a})) = [0, \max |a|].$$

However, if  $a \in C$  and  $T(a)$  is Fredholm, in which case  $\min |a| > 0$ , the question of finding

$$(\Sigma(T(a)) \cup \Sigma(T(\tilde{a}))) \cap [0, \min |a|)$$

is difficult.

# The first Szegő Theorem

## First-Order Trace Formulas

The *trace*  $\operatorname{tr} A$  of an  $n \times n$  matrix  $A = (a_{jk})_{j,k=1}^n$  is defined as usual:

$$\operatorname{tr} A = a_{11} + a_{22} + \dots + a_{nn}.$$

Denoting by  $\lambda_1(A), \dots, \lambda_n(A)$  the eigenvalues of  $A$ , we have

$$\operatorname{tr} A^k = \lambda_1^k(A) + \dots + \lambda_n^k(A)$$

for every natural number  $k$ . The *trace norm* of  $A$  is defined by

$$\|A\|_{\operatorname{tr}} = \sigma_1(A) + \dots + \sigma_n(A),$$

where  $\sigma_1(A), \dots, \sigma_n(A)$  are the singular values of  $A$ . It well know that

$$\|ABC\|_{\operatorname{tr}} \leq \|A\|_2 \|B\|_{\operatorname{tr}} \|C\|_2. \quad (37)$$



It is also well known that

$$|\operatorname{tr} A| \leq \|A\|_{\operatorname{tr}}. \quad (38)$$

Finally, we denote by  $\mathcal{O}$  the collection of all sequences  $\{K_n\}_{n=1}^{\infty}$  of complex  $n \times n$  matrices  $K_n$  such that

$$\frac{1}{n} \|K\|_{\operatorname{tr}} \rightarrow 0.$$

## Theorem

*Lemma* If  $a$  and  $b$  are Laurent polynomials, then

$$\{T_n(a)T_n(b) - T_n(ab)\} \in \mathcal{O}.$$

*Proof.* We have that

$$T_n(a)T_n(b) - T_n(ab) = -P_nH(a)H(\tilde{b})P_n - W_nH(\tilde{a})H(b)W_n.$$

The matrices  $H(a)H(\tilde{b})$  and  $H(\tilde{a})H(b)$  have only finitely many nonzero entries. Thus, since  $\|P_n\|_2 = \|W_n\|_2 = 1$ , inequality (37) yields

$$\frac{1}{n} \|P_nH(a)H(\tilde{b})P_n\|_{\text{tr}} \leq \frac{1}{n} \|P_n\|_2 \|H(a)H(\tilde{b})\|_{\text{tr}} \|P_n\|_2 = o(1),$$

$$\frac{1}{n} \|W_nH(\tilde{a})H(b)W_n\|_{\text{tr}} \leq \frac{1}{n} \|W_n\|_2 \|H(\tilde{a})H(b)\|_{\text{tr}} \|W_n\|_2 = o(1). \quad \blacksquare$$

## Theorem

*Lemma* If  $b$  is a Laurent polynomial and  $k \in \mathbf{N}$ , then

$$\{T_n^k(b) - T_n(b^k)\} \in \mathcal{O}.$$

*Proof.* The assertion is trivial for  $k = 1$ . Now suppose the assertion is true for some  $k \in \mathbf{N}$ . Then

$$T_n^{k+1}(b) = T_n^k(b)T_n(b) = T_n(b^k)T_n(b) + K_n T_n(b)$$

with some  $\{K_n\} \in \mathcal{O}$ . Since

$$\|K_n T_n(b)\|_{\text{tr}} \leq \|K_n\|_{\text{tr}} \|T_n(b)\|_2 \leq \|K_n\|_{\text{tr}} \|b\|_\infty,$$

it is clear that  $\{K_n T_n(b)\} \in \mathcal{O}$ . We have that

$$\{T_n(b^k)T_n(b) - T_n(b^{k+1})\} \in \mathcal{O}.$$

This gives that  $\{T_n^{k+1}(b) - T_n(b^{k+1})\} \in \mathcal{O}$ . ■

## Theorem

Let  $b$  be a Laurent polynomial and  $k \in \mathbf{N}$ . Then

$$\lim_{n \rightarrow \infty} \frac{1}{n} \sum_{j=1}^n \lambda_j^k(T_n(b)) = \frac{1}{2\pi} \int_0^{2\pi} (b(e^{i\theta}))^k d\theta. \quad (39)$$

*Proof.* First notice that

$$\frac{1}{n} \sum_{j=1}^n \lambda_j^k(T_n(b)) = \frac{1}{n} \operatorname{tr} T_n^k(b).$$

We have,

$$\frac{1}{n} \operatorname{tr} T_n^k(b) = \frac{1}{n} \operatorname{tr} T_n(b^k) + \frac{1}{n} \operatorname{tr} K_n$$

with  $\{K_n\} \in \mathcal{O}$ . Since

$$\begin{aligned} \frac{1}{n} \operatorname{tr} T_n(b^k) &= \frac{1}{n} \left( (b^k)_0 + \dots + (b^k)_0 \right) = \frac{1}{n} n (b^k)_0 \\ &= (b^k)_0 = \frac{1}{2\pi} \int_0^{2\pi} (b(e^{i\theta}))^k d\theta \end{aligned}$$

and, by (38),

$$\left| \frac{1}{n} \operatorname{tr} K_n \right| \leq \frac{1}{n} \|K_n\|_{\operatorname{tr}} = o(1),$$

we arrive at (39). ■

Theorems of the Szegő type say that, under certain conditions on  $a$  and  $F$ , including that  $a$  be real-valued,

$$\lim_{n \rightarrow \infty} \frac{1}{n} \sum_{j=1}^n F(\lambda_j(T_n(a))) = \frac{1}{2\pi} \int_0^{2\pi} F(a(\theta)) d\theta, \quad (40)$$

where  $\lambda_1(A) \leq \dots \leq \lambda_n(A)$  are the eigenvalues of a Hermitian  $n \times n$  matrix  $A$ , while theorems of the Avram-Parter type state that, again under appropriate assumptions on  $a$  and  $F$ ,

$$\lim_{n \rightarrow \infty} \frac{1}{n} \sum_{j=1}^n F(s_j(T_n(a))) = \frac{1}{2\pi} \int_0^{2\pi} F(|a(\theta)|) d\theta, \quad (41)$$

where  $s_1(A) \leq \dots \leq s_n(A)$  are the singular values of an  $n \times n$  matrix  $A$ . The function  $F$  in (40) and (41) is called a test function. Throughout this paper we assume that  $F$  is real-valued and that  $F$  is continuous on  $\mathbf{R}$ ,  $F \in C(\mathbf{R})$ , when considering (40) and continuous on  $[0, \infty)$ ,  $F \in C[0, \infty)$ , when dealing with (41).

Formula (40) goes back to Szegő [1920] who proved it for real-valued functions  $a$  in  $L^\infty := L^\infty(0, 2\pi)$  and compactly supported continuous functions  $F$  on  $\mathbf{R}$ .

Formula (41) was first established by Parter [1986] for all  $F \in C[0, \infty)$  under the assumptions that  $a$  is in  $L^\infty$  and that  $a$  is locally selfadjoint, which means that  $a = bc$  with a continuous  $2\pi$ -periodic function  $c$  and a real-valued function  $b$ . Avram [1988] subsequently proved (41) for all  $F \in C[0, \infty)$  and all  $a \in L^\infty$ .

Then Tyrtshnikov [1994-1996] showed that (40) and (41) hold for all continuous functions  $F$  with compact support if  $a$  is merely required to be in  $L^2 := L^2(0, 2\pi)$  and to be real-valued when dealing with (40).

Zamarashkin and Tyrtshnikov [1997-1998] were finally able to prove that (40) and (41) are true whenever  $F$  is continuous and compactly supported and  $a$  is in  $L^1$ , again requiring that  $a$  be real-valued when considering (40).

A very simple proof of the Zamarashkin-Tyrtshnikov result was given by Tilli [1998], who also extended (40) and (41) to all uniformly continuous functions  $F$  and all  $a \in L^1$ , assuming that  $a$  is real-valued in the case of (40).

Eventually Serra Capizzano [2002] derived (41) under the assumption that  $a \in L^p := L^p(0, 2\pi)$  ( $1 \leq p < \infty$ ) and  $F \in C[0, \infty)$  satisfies  $F(s) = O(s^p)$  as  $s \rightarrow \infty$ . Serra Capizzano's result implies in particular that (41) is valid for all  $a \in L^1$  under the sole assumption that  $F(s) = O(s)$ , which includes all the results concerning (41) listed before.

In [A.Böttcher, S.Grudsky and M.Schwartz. *Some problems concerning the test functions in the Szegő and Avram-Parter theorems. Operator Theory: Advances and Applications, Volum 187 (2008), 81-93 pp.*], we raised the question whether (40) and (41) are true whenever they make sense. To be more precise and to exclude “ $\infty - \infty$ ” cases, the question is whether (40) and (41) hold for all symbols  $a \in L^1$  (being real-valued in (40)) and all nonnegative and continuous test functions.

Here we make the following convention: we denote the functions under the integrals in (40) and (41), that is, the functions  $\theta \mapsto F(a(\theta))$  and  $\theta \mapsto F(|a(\theta)|)$ , by  $F(a)$  and  $F(|a|)$ , respectively, and if these functions are not in  $L^1$ , we define the right-hand sides of (40) and (41) to be  $\infty$  and interpret (40) and (41) as the statement that the limit on the left-hand side is  $\infty$ . It turns out that the answer to the question cited in the preceding paragraph is negative:

in [A.Böttcher, S.Grudsky and E.Maksimenko. *Pushing the Envelope of the Test Functions in the Szegő and Avram-Parter Theorems. Linea Algebra and its Applications* 429(2008), pp. 346-366],

we constructed a positive  $a \in L^1$  and a continuous  $F : \mathbf{R} \rightarrow [0, \infty)$  such that (40) and (41) are false.



In this work we also have proved the following result.

### Theorem

*Let  $a \in L^1$  be real-valued, let  $\Phi_{\pm} : [0, \infty) \rightarrow [0, \infty)$  be monotonously increasing and convex functions such that  $\Phi_{-}(0) = \Phi_{+}(0)$ , and suppose  $\Phi_{+}(a_{+})$  and  $\Phi_{-}(a_{-})$  are in  $L^1$ . Let  $F : \mathbf{R} \rightarrow [0, \infty)$  be a continuous function such that  $F(\lambda) \leq \Phi_{+}(\lambda)$  and  $F(-\lambda) \leq \Phi_{-}(\lambda)$  whenever  $\lambda > \lambda_0$ . Then we have that (40) is truth.*

# Limit spectral set-complex case.

## Trivial case

1. Triangular matrixes:

$$a_1(t) = \sum_{j=0}^{\infty} a_j t^j$$

or

$$a_2(t) = \sum_{j=0}^{\infty} a_j t^{-j}$$

$$T_n(a_1) = \begin{pmatrix} a_0 & 0 & 0 & \dots & 0 \\ a_1 & a_0 & 0 & \dots & 0 \\ a_2 & a_1 & a_0 & \dots & 0 \\ \vdots & \vdots & \vdots & \ddots & \vdots \\ a_{n-1} & a_{n-2} & a_{n-3} & \dots & a_0 \end{pmatrix}.$$

$$\operatorname{sp} T_n(a_{1,2}) = \{a_0\}$$

$$\liminf_{n \rightarrow \infty} \operatorname{sp} T_n(a) = \limsup_{n \rightarrow \infty} \operatorname{sp} T_n(a) = \{a\}$$

## 2. Tridiagonal Toeplitz Matrices:

By a tridiagonal Toeplitz matrix we understand a matrix of the form

$$T(a) = \begin{pmatrix} a_0 & a_{-1} & 0 & 0 & \dots \\ a_1 & a_0 & a_{-1} & 0 & \dots \\ 0 & a_1 & a_0 & a_{-1} & \dots \\ 0 & 0 & a_1 & a_0 & \dots \\ \dots & \dots & \dots & \dots & \dots \end{pmatrix}.$$

The symbol of this matrix is  $a(t) = a_{-1}t^{-1} + a_0 + a_1t$ . Suppose  $a_{-1} \neq 0$  and  $a_1 \neq 0$ . We fix any value  $\alpha = \sqrt{a_{-1}/a_1}$  and define  $\sqrt{a_1/a_{-1}} := 1/\alpha$  and  $\sqrt{a_1 a_{-1}} := a_1 \alpha$ . Recall that  $T_n(a)$  is the principal  $n \times n$  block of  $T(a)$ .

## Theorem

The eigenvalues of  $T_n(a)$  are

$$\lambda_j = a_0 + 2\sqrt{a_1 a_{-1}} \cos \frac{\pi j}{n+1} \quad (j = 1, \dots, n), \quad (42)$$

and an eigenvector for  $\lambda_j$  is  $x_j = (x_1^{(j)} \dots x_n^{(j)})^\top$  with

$$x_k^{(j)} = \left( \sqrt{\frac{a_1}{a_{-1}}} \right)^k \sin \frac{k\pi j}{n+1} \quad (k = 1, \dots, n). \quad (43)$$

*Proof.* Put  $b(t) = t + \alpha^2 t^{-1}$ . Thus,

$$T(b) = \begin{pmatrix} 0 & \alpha^2 & 0 & 0 & \dots \\ 1 & 0 & \alpha^2 & 0 & \dots \\ 0 & 1 & 0 & \alpha^2 & \dots \\ 0 & 0 & 1 & 0 & \dots \\ \dots & \dots & \dots & \dots & \dots \end{pmatrix}.$$

Since, obviously,  $T_n(a) = a_0 + a_1 T_n(b)$ , it suffices to prove that  $T_n(b)$  has the eigenvalues

$$\mu_j = 2\alpha \cos \frac{\pi j}{n+1} \quad (j = 1, \dots, n)$$

and that  $x_j = (x_1^{(j)} \dots x_n^{(j)})^\top$  with

$$x_k^{(j)} = \alpha^{-k} \sin \frac{k\pi j}{n+1} \quad (k = 1, \dots, n)$$

is an eigenvector for  $\mu_j$ . This is equivalent to proving the equalities

$$\begin{aligned} \alpha^2 x_2^{(j)} &= \mu_j x_1^{(j)}, \\ x_k^{(j)} + \alpha^2 x_{k+2}^{(j)} &= \mu_j x_{k+1}^{(j)} \quad (k = 1, \dots, n-2) \\ x_{n-1}^{(j)} &= \mu_j x_n^{(j)}. \end{aligned} \quad (44)$$

But these equalities can be easily verified: for example, (44) amounts to

$$\alpha^{-k} \sin \frac{k\pi j}{n+1} + \alpha^2 \alpha^{-k-2} \sin \frac{(k+2)\pi j}{n+1} = 2\alpha \alpha^{-k-1} \cos \frac{\pi j}{n+1} \cos \frac{(k+1)\pi j}{n+1},$$

which follows from the identity

$$\sin \beta + \sin \gamma = 2 \cos \frac{\beta - \gamma}{2} \sin \frac{\beta + \gamma}{2}. \quad \blacksquare$$

### Example

Let  $b(t) = t + \alpha^2 t^{-1}$ , where  $\alpha \in (0, 1)$ . The eigenvalues of  $T_n(b)$  are distributed along the interval  $(-2\alpha, 2\alpha)$ , which is the interval between the foci of the ellipse  $b(\mathbf{T})$ . Also notice that the eigenvectors are localized, that exponentially decaying, for  $\alpha \in (0, 1)$  (non-Hermitian case,  $b(\mathbf{T})$  is a non-degenerate ellipse) and that they are extended for  $\alpha = 1$  (Hermitian case,  $b(\mathbf{T})$  degenerates to  $[-2, 2]$ ).  $\blacksquare$



# Polynomial case

*P.Schmidt and F. Spitzer. The Toeplitz matrices of an arbitrary Laurent polynomial. Math. Scand. 8 (1960) 15–38.*

Because things are trivial in the case where  $T(b)$  is triangular, we will throughout this chapter assume that

$$b(t) = \sum_{j=-r}^s b_j t^j, \quad r \geq 1, \quad s \geq 1, \quad b_{-r} \neq 0, \quad b_s \neq 0.$$

As first observed by Schmidt and Spitzer, it turns out that the eigenvalue distribution of Toeplitz band matrices is in no obvious way related to the spectrum of the corresponding infinite matrices. To see this, choose  $\varrho \in (0, \infty)$  and put

$$b_\varrho(t) = \sum_{j=-r}^s b_j \varrho^j t^j.$$

Clearly,  $b_\varrho(\mathbf{T}) = b(\varrho\mathbf{T})$ . We have

$$T_n(b_\varrho) = \text{diag}(\varrho, \varrho^2, \dots, \varrho^n) T_n(b) \text{diag}(\varrho^{-1}, \varrho^{-2}, \dots, \varrho^{-n}), \quad (45)$$

and hence

$$\text{sp } T_n(b_\varrho) = \text{sp } T_n(b). \quad (46)$$

$$\Lambda_s(b) := \liminf_{n \rightarrow \infty} \text{sp } T_n(b)$$

as the set of all  $\lambda \in \mathbf{C}$  for which there exist  $\lambda_n \in \text{sp } T_n(b)$  such that  $\lambda_n \rightarrow \lambda$ , and we let

$$\Lambda_w(b) := \limsup_{n \rightarrow \infty} \text{sp } T_n(b)$$

stand for the set of all  $\lambda \in \mathbf{C}$  for which there are  $n_1 < n_2 < n_3 < \dots$  and  $\lambda_{n_k} \in \text{sp } T_{n_k}(b)$  such that  $\lambda_{n_k} \rightarrow \lambda$ . Obviously,  $\Lambda_s(b) \subset \Lambda_w(b)$ .

## Lemma

We have

$$\Lambda_s(b) \subset \Lambda_w(b) \subset \text{sp } T(b).$$

*Proof.* Let  $\lambda_0 \notin \text{sp } T(b)$ . Then,  $\{T_n(b - \lambda_0)\}$  is stable, that is,  $\|T_n^{-1}(b - \lambda_0)\|_2 \leq M < \infty$  for all  $n \geq n_0$ . It follows that if  $|\lambda - \lambda_0| < 1/(2M)$ , then  $\|T_n^{-1}(b - \lambda)\|_2 \leq 2M$  for all  $n \geq n_0$ , which shows that  $\lambda_0$  has a neighborhood  $U(\lambda_0)$  such that  $U(\lambda_0) \cap \text{sp } T_n(a) = \emptyset$  for all  $n \geq n_0$ . Consequently,  $\lambda_0 \notin \Lambda_w(b)$ . ■

## Corollary

We even have

$$\Lambda_s(b) \subset \Lambda_w(b) \subset \bigcap_{\varrho \in (0, \infty)} \text{sp } T(b_\varrho). \quad (47)$$

We will show that all inclusions of (47) are actually equalities. At the present moment, we restrict ourselves to giving another description of the intersection occurring in (47). For  $\lambda \in \mathbf{C}$ , put

$$Q(\lambda, z) = z^r(b(z) - \lambda) = b_{-r} + \dots + (b_0 - \lambda)z^r + \dots + b_s z^{r+s}$$

and denote by  $z_1(\lambda), \dots, z_{r+s}(\lambda)$  the zeros of  $Q(\lambda, z)$  for fixed  $\lambda$ :

$$Q(\lambda, z) = b_s \prod_{j=1}^{r+s} (z - z_j(\lambda)).$$

Label the zeros so that

$$|z_1(\lambda)| \leq |z_2(\lambda)| \leq \dots \leq |z_{r+s}(\lambda)|$$

and define

$$\Lambda(b) = \{\lambda \in \mathbf{C} : |z_r(\lambda)| = |z_{r+1}(\lambda)|\}. \quad (48)$$

*Proof.*  $T(b) - \lambda$  is invertible if and only if  $b(z) - \lambda$  has no zeros on  $\mathbf{T}$  and  $\text{wind}(b - \lambda) = 0$ . As  $\text{wind}(b - \lambda)$  equals the difference of the zeros and the poles of  $b(z) - \lambda$  in  $\mathbf{D} := \{z \in \mathbf{C} : |z| < 1\}$  and as the only pole of

$$b(z) - \lambda = b_{-r}z^{-r} + \dots + (b_0 - \lambda) + \dots + b_s z^s$$

is a pole of the multiplicity  $r$  at  $z = 0$ , it results that  $T(b) - \lambda$  is invertible if and only if  $b(z) - \lambda$  has no zeros on  $\mathbf{T}$  and exactly  $r$  zeros in  $\mathbf{D}$ .

Equivalently,  $T(b) - \lambda$  is invertible exactly if  $Q(\lambda, z)$  has no zeros on  $\mathbf{T}$  and precisely  $r$  zeros in  $\mathbf{D}$ .

Analogously,  $T(b_\varrho) - \lambda$  is invertible if and only if  $Q(\lambda, z)$  has no zero on  $\varrho^{-1}\mathbf{T}$  and exactly  $r$  zeros in  $\varrho^{-1}\mathbf{D}$ .

Now suppose  $\lambda \notin \Lambda(b)$ . Then  $|z_r(\lambda)| < |z_{r+1}(\lambda)|$ . Consequently, there is a  $\varrho$  such that  $|z_r(\lambda)| < \varrho < |z_{r+1}(\lambda)|$ . It follows that  $Q(\lambda, z)$  has no zero on  $\varrho\mathbf{T}$  and exactly  $r$  zeros in  $\varrho\mathbf{D}$ . Thus,  $T(b_{1/\varrho} - \lambda)$  is invertible and therefore  $\lambda \notin \bigcap_{\varrho \in (0, \infty)} \text{sp } T(b_\varrho)$ .

Conversely, suppose there is a  $\varrho \in (0, \infty)$  such that  $\lambda \notin \text{sp } T(b_\varrho)$ . Then, by what was said above,  $Q(\lambda, z)$  has no zeros on  $\varrho^{-1}\mathbf{T}$  and precisely  $r$  zeros in  $\varrho^{-1}\mathbf{D}$ . This implies that  $|z_r(\lambda)| < \varrho^{-1} < |z_{r+1}(\lambda)|$ , whence  $\lambda \notin \Lambda(b)$ . ■

### Theorem (Schmidt and Spitzer)

We have

$$\Lambda_s(b) = \Lambda_w(b) = \Lambda(b).$$

## Towards the Limiting Measure

If  $\lambda \notin \Lambda(b)$ , then, by definition (48), there is a real number  $\varrho$  satisfying

$$|z_r(\lambda)| < \varrho < |z_{r+1}(\lambda)|. \quad (49)$$

As usual, let  $D_n(a) = \det T_n(a)$ .

### Lemma

*There is a continuous function*

$$g : \mathbf{C} \setminus \Lambda(b) \rightarrow (0, \infty)$$

*such that*

$$\lim_{n \rightarrow \infty} |D_n(b - \lambda)|^{1/n} = g(\lambda)$$

*uniformly on compact subsets of  $\mathbf{C} \setminus \Lambda(b)$ . If  $\varrho$  is given by (49), then*

$$g(\lambda) = \exp \int_0^{2\pi} \log |b_\varrho(e^{i\theta}) - \lambda| \frac{d\theta}{2\pi}. \quad (50)$$

## Theorem

(Hirschman) The measures  $d\mu_n$  converge weakly to the measure which is supported on  $\Lambda(b)$  and equals

$$\frac{1}{2\pi} \frac{1}{g} \left| \frac{\partial g}{\partial n_1} + \frac{\partial g}{\partial n_2} \right| ds \quad \text{on } \Lambda(b). \quad (51)$$

In other terms,

$$\frac{1}{n} \sum_{j=1}^n \varphi(\lambda_j(T_n(b))) \rightarrow \frac{1}{2\pi} \int_{\Lambda(b)} \varphi(\lambda) \frac{1}{g(\lambda)} \left| \frac{\partial g}{\partial n_1}(\lambda) + \frac{\partial g}{\partial n_2}(\lambda) \right| ds(\lambda) \quad (52)$$

for every  $\varphi \in C(\mathbf{C})$  with compact support.



# The ranges $b(\mathbf{T})$ for two Laurent polynomials and the eigenvalues of the matrices $T_n(b)$ .

(Legacy of Olga Grudskaya)

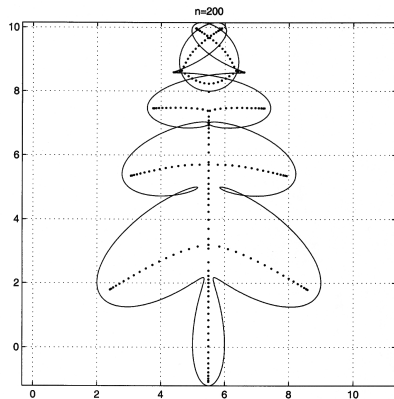
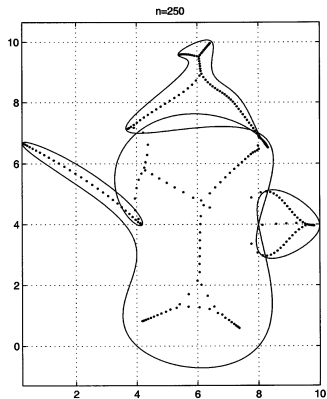

# The ranges $b(\mathbf{T})$ for two Laurent polynomials and the eigenvalues of the matrices $T_n(b)$ .

(Legacy of Olga Grudskaya)

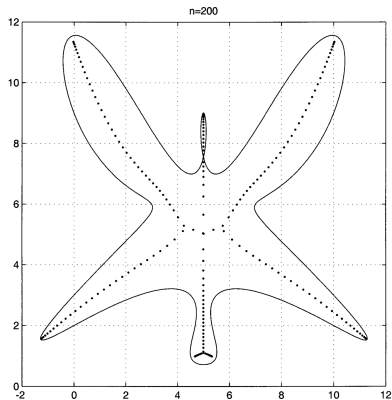
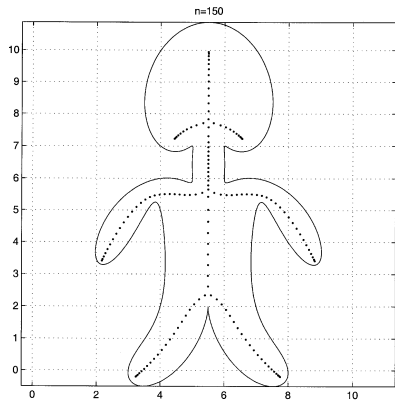

# The ranges $b(\mathbf{T})$ for two Laurent polynomials and the eigenvalues of the matrices $T_n(b)$ .

(Legacy of Olga Grudskaya)

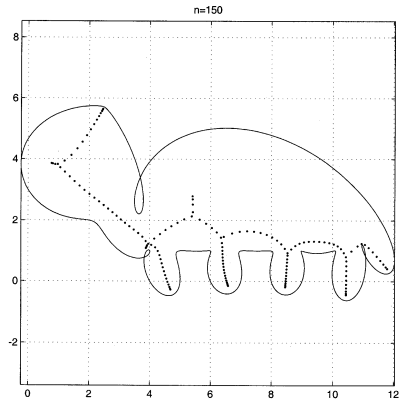
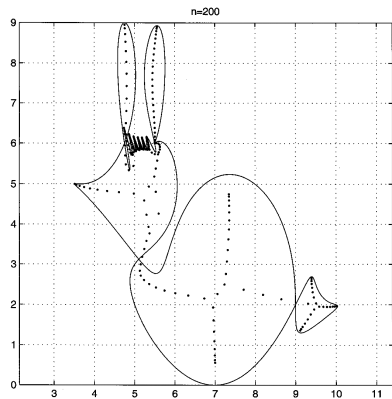

# Asymptotics of eigenvalues and eigenvectors

Much attention has been paid to the extreme eigenvalues, that is, to the behavior of  $\lambda_j^{(n)}$  as  $n \rightarrow \infty$  and  $j$  or  $n - j$  remain fixed. The pioneering work on this problem was done by Kac, Murdock, Szegö (1953), Widom (1958) and Parter (1961).

Recent work on and applications of extreme eigenvalues include the authors:

- S.Serra Capizzano and P.Tilli 1996-1999,
- C.Hurvich and Yi Lu 2005,
- A.Novoseltsev and I.Simonenko 2005,
- A.Böttcher, S.Grudsky and E.Maximenko 2008.

H.Widom (1958)

$$a = \bar{a}, \quad g(\varphi) := a(e^{i\varphi}), \quad g(0) = 0, \quad g'(0) = 0, \quad g''(0) > 0$$

$$\lambda_j^{(n)} = \frac{g''(0)}{2} \left( \frac{\pi j}{n+1} \right)^2 \left( 1 + \frac{w_0}{n+1} \right) + O\left( \frac{1}{n^4} \right), \quad j - \text{fixed}$$

The purpose of this report is to explore the behavior of all  $\lambda_j^{(n)}$ . That is the asymptotics of  $\lambda_j^{(n)}$  as  $n \rightarrow \infty$  uniformly by parameter  $d := \frac{\pi j}{n+1} \in (0, \pi)$ .

## 1. Tridiagonal Toeplitz Matrices

$$a_1(t) = a_{-1}t^{-1} + a_0 + a_1t$$

$$\lambda_j^{(n)} = a_0 + 2\sqrt{a_1a_{-1}} \cos \frac{\pi j}{n+1}$$

2.

$$a_2(t) = \frac{1}{a_1(t)}$$

# Real value symbols.

The function  $a$  is a Laurent polynomial

$$a(t) = \sum_{k=-r}^r a_k t^k \quad (t = e^{ix} \in \mathbf{T})$$

with  $r \geq 1$ ,  $a_r \neq 0$ , and  $\overline{a_k} = a_{-k}$  for all  $k$ . That is  $a$  is real-valued on  $\mathbf{T}$ . It may be assumed without loss of generality that  $a(\mathbf{T}) = [0, M]$  with  $M > 0$  and that  $a(1) = 0$  and  $a(e^{i\varphi_0}) = M$  for some  $\varphi_0 \in (0, 2\pi)$ . We require that the function  $g(x) := a(e^{ix})$  is strictly increasing on  $(0, \varphi_0)$  and strictly decreasing on  $(\varphi_0, 2\pi)$  and that the second derivatives of  $g$  at  $x = 0$  and  $x = \varphi_0$  are nonzero. For each  $\lambda \in [0, M]$ , there exist exactly one  $\varphi_1(\lambda) \in [0, \varphi_0]$  and exactly one  $\varphi_2(\lambda) \in [\varphi_0 - 2\pi, 0]$  such that

$$g(\varphi_1(\lambda)) = g(\varphi_2(\lambda)) = \lambda;$$

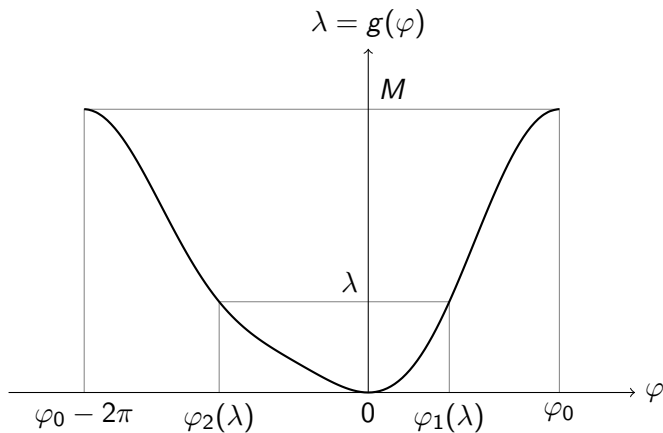

We put

$$\varphi(\lambda) = \frac{\varphi_1(\lambda) - \varphi_2(\lambda)}{2}.$$

Clearly,  $\varphi(0) = 0$ ,  $\varphi(M) = \pi$ ,  $\varphi$  is a continuous and strictly increasing map of  $[0, M]$  onto  $[0, \pi]$ .

For  $\lambda \in \mathbf{C}$ , we write  $a - \lambda$  in the form

$$\begin{aligned} a(t) - \lambda &= t^{-r}(a_r t^{2r} + \dots + (a_0 - \lambda)t^r + \dots + a_{-r}) \\ &= a_r t^{-r} \prod_{k=1}^{2r} (t - z_k(\lambda)) \end{aligned} \quad (53)$$

with complex numbers  $z_k(\lambda)$ . We may label the zeros  $z_1(\lambda), \dots, z_{2r}(\lambda)$  so that each  $z_k$  is a continuous function of  $\lambda \in \mathbf{C}$ . Now take  $\lambda \in [0, M]$ . Then  $a - \lambda$  has exactly the two zeros  $e^{i\varphi_1(\lambda)}$  and  $e^{i\varphi_2(\lambda)}$  on  $\mathbf{T}$ . We put

$$z_r(\lambda) = e^{i\varphi_1(\lambda)}, \quad z_{r+1}(\lambda) = e^{i\varphi_2(\lambda)}.$$



For  $t \in \mathbf{T}$  we have (53) on the one hand, and since  $a(t) - \lambda$  is real, we get

$$\begin{aligned} a(t) - \lambda &= \overline{a(t) - \lambda} = \overline{a_r} t^r \prod_{k=1}^{2r} \left( \frac{1}{t} - \bar{z}_k(\lambda) \right) \\ &= \overline{a_r} \left( \prod_{k=1}^{2r} \bar{z}_k(\lambda) \right) t^{-r} \prod_{k=1}^{2r} \left( t - \frac{1}{\bar{z}_k(\lambda)} \right) \end{aligned} \quad (54)$$

Comparing (53) and (54) we see that the zeros in  $\mathbf{C} \setminus \mathbf{T}$  may be relabeled so that they appear in pairs  $z_k(\lambda), 1/\bar{z}_k(\lambda)$  with  $|z_k(\lambda)| > 1$ . Put  $u_k(\lambda) = z_k(\lambda)$  for  $1 \leq k \leq r-1$ . We relabel  $z_{r+2}(\lambda), \dots, z_{2r}(\lambda)$  to get  $z_{2r-k}(\lambda) = 1/\bar{u}_k(\lambda)$  for  $1 \leq k \leq r-1$ . In summary, for  $\lambda \in [0, M]$  we have

$$\begin{aligned} \mathcal{Z} &:= \{z_1(\lambda), \dots, z_{r-1}(\lambda), e^{i\varphi_1(\lambda)}, e^{i\varphi_2(\lambda)}, z_{r+2}(\lambda), \dots, z_{2r}(\lambda)\} \\ &= \{u_1(\lambda), \dots, u_{r-1}(\lambda), e^{i\varphi_1(\lambda)}, e^{i\varphi_2(\lambda)}, 1/\bar{u}_{r-1}(\lambda), \dots, 1/\bar{u}_1(\lambda)\}. \end{aligned} \quad (55)$$

Put

$$h_\lambda(z) = \prod_{k=1}^{r-1} \left(1 - \frac{z}{u_k(\lambda)}\right), \quad \sigma(\lambda) = \frac{\varphi_1(\lambda) + \varphi_2(\lambda)}{2},$$
$$d_0(\lambda) = (-1)^r a_r e^{i\sigma(\lambda)} \prod_{k=1}^{r-1} u_k(\lambda). \quad (56)$$

For  $t \in \mathbf{T}$  we then may write

$$a(t) - \lambda = d_0(\lambda) e^{i\varphi(\lambda)} \left(1 - \frac{t}{e^{i\varphi_1(\lambda)}}\right) \left(1 - \frac{e^{i\varphi_2(\lambda)}}{t}\right) h_\lambda(t) \overline{h_\lambda(t)}.$$

# Widom's formula

H. Widom proved that if  $\lambda \in \mathbf{C}$  and the points  $z_1(\lambda), \dots, z_{2r}(\lambda)$  are pairwise distinct, then the determinant of  $T_n(a - \lambda)$  is

$$\det T_n(a - \lambda) = \sum_{J \subset \mathcal{Z}, |J|=r} C_J W_J^n \quad (57)$$

where the sum is over all subsets  $J$  of cardinality  $r$  of the set  $\mathcal{Z}$  given by (55) and, with  $\bar{J} := \mathcal{Z} \setminus J$ ,

$$C_J = \prod_{z \in J} z^r \prod_{z \in J, w \in \bar{J}} \frac{1}{z - w}, \quad W_J = (-1)^r a_r \prod_{z \in J} z.$$

## Lemma (1)

Let  $\lambda \in (0, M)$  and put

$$J_1 = \{u_1, \dots, u_{r-1}, e^{i\varphi_1}\}, \quad J_2 = \{u_1, \dots, u_{r-1}, e^{i\varphi_2}\}.$$

Then

$$W_{J_1} = d_0 e^{i\varphi}, \quad C_{J_1} = \frac{d_1 e^{i(\varphi+\theta)}}{2i \sin \varphi},$$
$$W_{J_2} = d_0 e^{-i\varphi}, \quad C_{J_2} = -\frac{d_1 e^{-i(\varphi+\theta)}}{2i \sin \varphi}.$$

Where  $d_0 := d_0(\lambda) = (-1)^r a_r e^{i\sigma(\lambda)} \prod_{k=1}^{r-1} u_k(\lambda)$ ;  $\varphi(\lambda) := \varphi = \frac{\varphi_1 - \varphi_2}{2}$ .

$$d := d_1(\lambda) = \frac{1}{|h_\lambda(e^{i\varphi_1(\lambda)})h_\lambda(e^{i\varphi_2(\lambda)})|} \prod_{k,s=1}^{r-1} \left(1 - \frac{1}{u_k(\lambda)\bar{u}_s(\lambda)}\right)^{-1} \quad (58)$$

$$\Theta(\lambda) := \frac{h_\lambda(e^{i\varphi_1(\lambda)})}{h_\lambda(e^{i\varphi_2(\lambda)})} = \prod_{k=1}^{r-1} \frac{1 - e^{i\varphi_1(\lambda)}/u_k(\lambda)}{1 - e^{i\varphi_2(\lambda)}/u_k(\lambda)}.$$

$$\theta := \theta(\lambda) := \arg \Theta(\lambda).$$

### Theorem (A)

For every  $\lambda \in (0, M)$  and every  $\delta < \delta_0$ ,

$$\det T_n(a - \lambda) = \frac{d_1(\lambda)d_0^n(\lambda)}{\sin \varphi(\lambda)} \left[ \sin \left( (n+1)\varphi(\lambda) + \theta(\lambda) \right) + O(e^{-\delta n}) \right].$$

## Lemma (2)

There is a natural number  $n_0 = n_0(a)$  such that if  $n \geq n_0$ , then the function

$$f_n : [0, M] \rightarrow [0, (n + 1)\pi], \quad f_n(\lambda) = (n + 1)\varphi(\lambda) + \theta(\lambda)$$

is bijective and increasing.

# Main result.

## Theorem (1)

If  $n$  is sufficiently large, then the function

$$[0, M] \rightarrow [0, (n+1)\pi], \quad \lambda \mapsto (n+1)\varphi(\lambda) + \theta(\lambda)$$

is bijective and increasing. For  $1 \leq j \leq n$ , the eigenvalues  $\lambda_j^{(n)}$  satisfy

$$(n+1)\varphi(\lambda_j^{(n)}) + \theta(\lambda_j^{(n)}) = \pi j + O(e^{-\delta n}),$$

and if  $\lambda_{j,*}^{(n)} \in (0, M)$  is the uniquely determined solution of the equation

$$(n+1)\varphi(\lambda_{j,*}^{(n)}) + \theta(\lambda_{j,*}^{(n)}) = \pi j,$$

then  $|\lambda_j^{(n)} - \lambda_{j,*}^{(n)}| = O(e^{-\delta n})$ .

## Iteration procedure.

Here is an iteration procedure for approximating the numbers  $\lambda_{j,*}^{(n)}$  and thus the eigenvalues  $\lambda_j^{(n)}$ . We know that  $\varphi : [0, M] \rightarrow [0, \pi]$  is bijective and increasing. Let  $\psi : [0, \pi] \rightarrow [0, M]$  be the inverse function. The equation

$$(n+1)\varphi(\lambda) + \theta(\lambda) = \pi j$$

is equivalent to the equation

$$\lambda = \psi \left( \frac{\pi j - \theta(\lambda)}{n+1} \right).$$

We define  $\lambda_{j,0}^{(n)}, \lambda_{j,1}^{(n)}, \lambda_{j,2}^{(n)}, \dots$  iteratively by

$$\lambda_{j,0}^{(n)} = \psi \left( \frac{\pi j}{n+1} \right), \quad \lambda_{j,k+1}^{(n)} = \psi \left( \frac{\pi j - \theta(\lambda_{j,k}^{(n)})}{n+1} \right) \quad \text{for } k = 0, 1, 2, \dots$$

Put 
$$\gamma = \sup_{\lambda \in (0, M)} \left| \frac{\theta'(\lambda)}{\varphi'(\lambda)} \right|.$$



## Theorem (2)

There is a constant  $\gamma_0$  depending only on  $a$  such that if  $n$  is sufficiently large, then

$$|\lambda_{j,k}^{(n)} - \lambda_{j,*}^{(n)}| \leq \gamma_0 \left( \frac{\gamma}{n+1} \right)^k \frac{1}{n+1} \frac{|\theta(\lambda_{j,0}^{(n)})|}{\varphi'(\lambda_{j,0}^{(n)})}$$

for all  $1 \leq j \leq n$  and all  $k \geq 0$ .

# Asymptotics of the eigenvalues.

## Theorem (3)

We have

$$\lambda_j^{(n)} = \psi(d) - \frac{\psi'(d)\theta(\psi(d))}{n+1} + O\left(\frac{(\theta(\psi(d)))^2}{n^2}\right) + O\left(\frac{\psi'(d)\theta(\psi(d))}{n^2}\right).$$

Where  $d = \frac{\pi j}{n+1}$  and  $O(\cdot)$  means that

$$O\left(\frac{(\theta(\psi(d)))^2 + \psi'(d)\theta(\psi(d))}{n^2}\right) \leq \text{const} \frac{(\theta(\psi(d)))^2 + \psi'(d)\theta(\psi(d))}{n^2}.$$

Where "const" does not depend of  $n$  and  $d \in (0, \pi)$ . In particular

$$\lambda_j^{(n)} = \psi(d) - \frac{\psi'(d)\theta(\psi(d))}{n+1} + O\left(\frac{1}{n^2}\right), \quad (59)$$

uniformly in  $d$  from compact subsets of  $(0, \pi)$ .

This is asymptotics for inner eigenvalues!

# Asymptotic for extreme eigenvalues.

## Theorem (4)

If  $n \rightarrow \infty$  and  $j/n \rightarrow 0$ , then

$$\lambda_j^{(n)} = \sum_{k=0}^3 (-1)^k \frac{\psi^{(k)}(d)}{k!} \left( \frac{\theta(\psi(d))}{n+1} \right)^k + O\left(\frac{1}{n^4}\right) \quad (60)$$

$$= \frac{g''(0)}{2} \left( \frac{\pi j}{n+1} \right)^2 \left( 1 + \frac{w_0}{n+1} \right) + O\left(\frac{j^4}{n^4}\right) \quad (61)$$

$$= \frac{g''(0)}{2} \left( \frac{\pi j}{n+1} \right)^2 + O\left(\frac{j^3}{n^3}\right), \quad (62)$$

$$w_0 = \frac{1}{\pi} \int_{-\pi}^{\pi} \left( \frac{g'(x)}{g(x)} - \cot \frac{x}{2} - \frac{g'''(0)}{3g''(0)} \right) \cot \frac{x}{2} dx. \quad (63)$$

(10) coincides with Widom's formula. But (10) holds if  $d = \frac{\pi j}{n+1} \ll 1$ , while Widom's formula holds for  $j$  is fixed.

## Even case.

Let be  $g(-\varphi) = g(\varphi)$ , ( $g(\varphi) = a(e^{i\varphi})$ ), then  
 $g(\pi) = M$ ,  $\varphi_1(\lambda) = -\varphi_2(\lambda) \in [0, \pi]$ ,  $\varphi(\lambda) = \frac{\varphi_1(\lambda) - \varphi_2(\lambda)}{2} = \varphi_1(\lambda)$  and  
function  $\psi(x) := \varphi^{-1}(x) = g(x)$ .

This the main formula has the form

$$\lambda_j^{(n)} = g(d) - \frac{g'(d)\theta(g(d))}{n+1} + O\left(\frac{1}{n^2}\right).$$

### Remark

Starting with  $\lambda_{j,2}^{(n)}, \lambda_{j,3}^{(n)}, \dots$  instead of  $\lambda_{j,1}^{(n)}$  one can get as many terms of the expansions (8) or (9) as desired.

## Examples.

We consider  $T_n(a)$ , denote by  $\lambda_j^{(n)}$  the  $j$ th eigenvalue, by  $\lambda_{j,*}^{(n)}$  the approximation to  $\lambda_j^{(n)}$  given by Theorem (1), and by  $\lambda_{j,k}^{(n)}$  the  $k$ th approximation to  $\lambda_j^{(n)}$  delivered by the iteration procedure. We put

$$\Delta_*^{(n)} = \max_{1 \leq j \leq n} |\lambda_j^{(n)} - \lambda_{j,*}^{(n)}|, \quad \Delta_k^{(n)} = \max_{1 \leq j \leq n} |\lambda_j^{(n)} - \lambda_{j,k}^{(n)}|.$$

We let  $w_0$  be the constant (63), denote by

$$\lambda_{j,W}^{(n)} = \frac{g''(0)}{2} \left( \frac{\pi j}{n+1} \right)^2 \left( 1 + \frac{w_0}{n+1} \right)$$

Widom's approximation for the  $j$ th extreme eigenvalue given by (61), and put

$$\Delta_{j,W}^{(n)} = \frac{(n+1)^4}{\pi^4 j^4} |\lambda_j^{(n)} - \lambda_{j,W}^{(n)}|.$$

## Example (1)

(A symmetric pentadiagonal matrix) Let

$a(t) = 8 - 5t - 5t^{-1} + t^2 + t^{-2}$ . In that case

$$g(x) = 8 - 10 \cos x + 2 \cos 2x = 4 \sin^2 \frac{x}{2} + 16 \sin^4 \frac{x}{2},$$

$a(\mathbf{T}) = [0, 20]$ , and for  $\lambda \in [0, 20]$ , the roots of  $a(z) - \lambda$  are  $e^{-i\varphi(\lambda)}$ ,  $e^{i\varphi(\lambda)}$ ,  $u(\lambda)$ ,  $1/u(\lambda)$  with

$$\varphi(\lambda) = \arccos \frac{5 - \sqrt{1 + 4\lambda}}{4} = 2 \arcsin \frac{\sqrt{\sqrt{1 + 4\lambda} - 1}}{2\sqrt{2}},$$

$$u(\lambda) = \frac{5 + \sqrt{1 + 4\lambda}}{4} + \frac{\sqrt{5 + 2\lambda + 5\sqrt{1 + 4\lambda}}}{2\sqrt{2}}$$

and we have

$$g''(0) = 2, \quad w_0 = \frac{4}{u(0) - 1} = 2\sqrt{5} - 2.$$

## Example (1)

The errors  $\Delta_*^{(n)}$  are

	$n = 10$	$n = 20$	$n = 50$	$n = 100$	$n = 150$
$\Delta_*^{(n)}$	$5.4 \cdot 10^{-7}$	$1.1 \cdot 10^{-11}$	$5.2 \cdot 10^{-25}$	$1.7 \cdot 10^{-46}$	$9.6 \cdot 10^{-68}$

and for  $\Delta_k^{(n)}$  and  $\Delta_{j,W}^{(n)}$  we have

	$n = 10$	$n = 100$	$n = 1000$	$n = 10000$
$\Delta_1^{(n)}$	$9.0 \cdot 10^{-2}$	$1.1 \cdot 10^{-4}$	$1.1 \cdot 10^{-6}$	$1.1 \cdot 10^{-8}$
$\Delta_2^{(n)}$	$2.2 \cdot 10^{-4}$	$2.8 \cdot 10^{-7}$	$2.9 \cdot 10^{-10}$	$2.9 \cdot 10^{-13}$
$\Delta_3^{(n)}$	$1.1 \cdot 10^{-5}$	$1.5 \cdot 10^{-9}$	$1.5 \cdot 10^{-13}$	$1.5 \cdot 10^{-17}$

## Example (1)

	$n = 10$	$n = 100$	$n = 1000$	$n = 10000$	$n = 100000$
$\Delta_{1,W}^{(n)}$	1.462	1.400	1.383	1.381	1.381
$\Delta_{2,W}^{(n)}$	0.997	1.046	1.034	1.033	1.033
$\Delta_{3,W}^{(n)}$	0.840	0.979	0.970	0.968	0.968



## Example (2)

(A Hermitian heptadiagonal matrix)

$$a(t) = 24 + (-12 - 3i)t + (-12 + 3i)t^{-1} + it^3 - it^{-3},$$

$$g(x) = 48 \sin^2 \frac{x}{2} + 8 \sin^3 x.$$

	$n = 10$	$n = 20$	$n = 50$	$n = 100$	$n = 150$
$\Delta_*^{(n)}$	$6.6 \cdot 10^{-6}$	$1.2 \cdot 10^{-10}$	$7.6 \cdot 10^{-24}$	$1.4 \cdot 10^{-45}$	$3.3 \cdot 10^{-67}$

	$n = 10$	$n = 100$	$n = 1000$	$n = 10000$
$\Delta_1^{(n)}$	$1.0 \cdot 10^{-2}$	$1.4 \cdot 10^{-4}$	$1.5 \cdot 10^{-6}$	$1.5 \cdot 10^{-8}$
$\Delta_2^{(n)}$	$3.2 \cdot 10^{-4}$	$5.8 \cdot 10^{-7}$	$5.9 \cdot 10^{-10}$	$5.9 \cdot 10^{-13}$
$\Delta_3^{(n)}$	$1.4 \cdot 10^{-5}$	$2.4 \cdot 10^{-9}$	$2.5 \cdot 10^{-13}$	$2.6 \cdot 10^{-17}$

## Example (2)

	$n = 10$	$n = 100$	$n = 1000$	$n = 10000$	$n = 100000$
$\Delta_{1,W}^{(n)}$	5.149	7.344	7.565	7.587	7.589
$\Delta_{2,W}^{(n)}$	4.106	7.386	7.623	7.645	7.647
$\Delta_{3,W}^{(n)}$	2.606	7.370	7.633	7.656	7.658

# New problems

## 1. Extremums of higher orders

- ▶  $a(1) = 0$  and  $a(e^{ix}) = M$ ,  $\varphi_0 \in (0, 2\pi)$ ;  
 $g(x) =: a(e^{ix})$  is strictly increasing on  $(0, \varphi_0)$  and strictly decreasing on  $(\varphi_0, 2\pi)$  and  
 $g'(0) = g''(0) = g'''(0) = g'(\varphi_0) = g''(\varphi_0) = g'''(\varphi_0) = 0$   
with  $g^{IV}(0) \neq 0$  and  $g^{IV}(\varphi_0) \neq 0$ ;
- ▶ Several extremums of different orders;
- ▶ Complex values even symbols  $a(e^{ix}) = a(e^{-ix})$ ,  $x \in (0, \pi)$ .  
Limit spectral set  $\Lambda(a) = \text{Im}(a)$ .

## 2. Continuous case.

# Eigenvectors

The adjugate matrix  $\text{adj } B$  of an  $n \times n$  matrix  $B = (b_{jk})_{j,k=1}^n$  is defined by

$$(\text{adj } B)_{jk} = (-1)^{j+k} \det M_{kj}$$

where  $M_{kj}$  is the  $(n-1) \times (n-1)$  matrix that results from  $B$  by deleting the  $k$ th row and the  $j$ th column. We have

$$(A - \lambda I) \text{adj } (A - \lambda I) = (\det(A - \lambda I))I.$$

Thus, if  $\lambda$  is an eigenvalue of  $A$ , then each nonzero column of  $\text{adj } (A - \lambda I)$  is an eigenvector. For an invertible matrix  $B$ ,

$$\text{adj } B = (\det B)B^{-1}. \quad (64)$$

Formulas for  $\det T_n(b)$  and  $T_n^{-1}(b)$  were established by Widom and Trench, respectively.

## Theorem

Let  $b(t) = \sum_{k=-p}^q b_k t^k = b_p t^{-q} \prod_{j=1}^{p+q} (t - z_j)$  ( $t \in \mathbf{T}$ )

where  $p \geq 1$ ,  $q \geq 1$ ,  $b_p \neq 0$ , and  $z_1, \dots, z_{p+q}$  are pairwise distinct nonzero complex numbers. If  $n > p + q$  and  $1 \leq m \leq n$ , then the  $m$ th entry of the first column of  $\text{adj } T_n(b)$  is

$$[\text{adj } T_n(b)]_{m,1} = \sum_{J \subset \mathcal{Z}, |J|=p} C_J W_J^n \sum_{z \in J} S_{m,J,z} \quad (65)$$

where  $\mathcal{Z} = \{z_1, \dots, z_{p+q}\}$ , the sum is over all sets  $J \subset \mathcal{Z}$  of cardinality  $p$ , and, with  $\bar{J} := \mathcal{Z} \setminus J$ ,

$$C_J = \prod_{z \in J} z^q \prod_{z \in J, w \in \bar{J}} \frac{1}{z - w}, \quad W_J = (-1)^p b_p \prod_{z \in J} z,$$
$$S_{m,J,z} = -\frac{1}{b_p} \frac{1}{z^m} \prod_{w \in J \setminus \{z\}} \frac{1}{z - w}.$$

# Formulas for the eigenvectors (in the case $a(e^{i\varphi}) = a(e^{-i\varphi})$ )

Introduce the vectors  $y_k^{(n)}$  with the following coordinates:

$$y_{k,m}^{(n)} := \sin\left(m\varphi(\lambda) + \frac{\theta(\lambda)}{2}\right) - \sum_{j=1}^{r-1} Q_j(\lambda) \left( \frac{1}{u_j(\lambda)^m} + \frac{(-1)^{k+1}}{u_j(\lambda)^{n+1-m}} \right),$$

$$\text{where } Q_j(\lambda) = \frac{|h_\lambda(e^{i\varphi(\lambda)})| \sin \varphi(\lambda)}{(u_j(\lambda) - e^{i\varphi(\lambda)})(u_j(\lambda) - e^{-i\varphi(\lambda)})h'_\lambda(u_j(\lambda))}, \quad \lambda = \lambda_k^{(n)}.$$

Let  $w_k^{(n)}$  be the normalized vector  $y_k^{(n)}$  and  $v_n^k$  be normalized eigenvector.

## Theorem (5)

$$\varrho(v_k^{(n)}, w_k^{(n)}) \leq Ce^{-n\delta},$$

where  $C$  and  $\delta$  depend only on the symbol.

In the nonsymmetric case the formulas for  $y_k^{(n)}$  are a little more complicated.

# Numerical results

Given  $T_n(a)$ , determine the approximate eigenvalue  $\lambda_{j,*}^{(n)}$  from the equation

$$(n+1)\varphi(\lambda_{j,*}^{(n)}) + \theta(\lambda_{j,*}^{(n)}) = \pi j.$$

Put

$$w_{j,*}^{(n)} = \frac{w_j^{(n)}(\lambda_{j,*}^{(n)})}{\|w_j^{(n)}(\lambda_{j,*}^{(n)})\|_2}.$$

We define the distance between the normalized eigenvector  $v_j^{(n)}$  and the normalized vector  $w_{j,*}^{(n)}$  by

$$\varrho(v_j^{(n)}, w_{j,*}^{(n)}) := \min_{\tau \in \mathbf{T}} \|\tau v_j^{(n)} - w_{j,*}^{(n)}\|_2 = \sqrt{2 - 2\langle v_j^{(n)}, w_{j,*}^{(n)} \rangle}$$

and put

$$\Delta_*^{(n)} = \max_{1 \leq j \leq n} |\lambda_j^{(n)} - \lambda_{j,*}^{(n)}|,$$

$$\Delta_{v,w}^{(n)} = \max_{1 \leq j \leq n} \varrho(v_j^{(n)}, w_{j,*}^{(n)}),$$

$$\Delta_r^{(n)} = \max_{1 \leq j \leq n} \|T_n(a)w_{j,*}^{(n)} - \lambda_{j,*}^{(n)}w_{j,*}^{(n)}\|_2.$$

The tables following below show these errors for three concrete choices of the generating function  $a$ .

For  $a(t) = 8 - 5t - 5t^{-1} + t^2 + t^{-2}$  we have

	$n = 10$	$n = 20$	$n = 50$	$n = 100$	$n = 150$
$\Delta_*^{(n)}$	$5.4 \cdot 10^{-7}$	$1.1 \cdot 10^{-11}$	$5.2 \cdot 10^{-25}$	$1.7 \cdot 10^{-46}$	$9.6 \cdot 10^{-68}$
$\Delta_{v,w}^{(n)}$	$2.0 \cdot 10^{-6}$	$1.1 \cdot 10^{-10}$	$2.0 \cdot 10^{-23}$	$1.9 \cdot 10^{-44}$	$2.0 \cdot 10^{-65}$
$\Delta_r^{(n)}$	$8.0 \cdot 10^{-6}$	$2.7 \cdot 10^{-10}$	$3.4 \cdot 10^{-23}$	$2.2 \cdot 10^{-44}$	$1.9 \cdot 10^{-65}$



If  $a(t) = 8 + (-4 - 2i)t + (-4 - 2i)t^{-1} + it - it^{-1}$  then

	$n = 10$	$n = 20$	$n = 50$	$n = 100$	$n = 150$
$\Delta_*^{(n)}$	$3.8 \cdot 10^{-8}$	$2.8 \cdot 10^{-13}$	$2.9 \cdot 10^{-30}$	$5.9 \cdot 10^{-58}$	$1.6 \cdot 10^{-85}$
$\Delta_{v,w}^{(n)}$	$1.8 \cdot 10^{-7}$	$4.7 \cdot 10^{-13}$	$2.0 \cdot 10^{-29}$	$7.0 \cdot 10^{-57}$	$2.4 \cdot 10^{-84}$
$\Delta_r^{(n)}$	$5.4 \cdot 10^{-7}$	$1.3 \cdot 10^{-12}$	$2.7 \cdot 10^{-29}$	$6.7 \cdot 10^{-57}$	$1.9 \cdot 10^{-84}$

In the case where  $a(t) = 24 + (-12 - 3i)t + (-12 + 3i)t^{-1} + it^3 - it^{-3}$  we get

	$n = 10$	$n = 20$	$n = 50$	$n = 100$	$n = 150$
$\Delta_*^{(n)}$	$6.6 \cdot 10^{-6}$	$1.2 \cdot 10^{-10}$	$7.6 \cdot 10^{-24}$	$1.4 \cdot 10^{-45}$	$3.3 \cdot 10^{-67}$
$\Delta_{v,w}^{(n)}$	$1.9 \cdot 10^{-6}$	$1.3 \cdot 10^{-10}$	$2.0 \cdot 10^{-23}$	$7.2 \cdot 10^{-45}$	$2.8 \cdot 10^{-66}$
$\Delta_r^{(n)}$	$2.5 \cdot 10^{-5}$	$8.6 \cdot 10^{-10}$	$7.3 \cdot 10^{-23}$	$1.9 \cdot 10^{-44}$	$5.9 \cdot 10^{-66}$

# Complex value case

$$a(t) = t^{-1}(1-t)^\alpha f(t), \quad \alpha \in R_+ \setminus N$$

where

1.  $f(t) \in H^\infty \cap C^\infty$ .
2.  $f$  can be analytically extended to a neighborhood of  $\mathbb{T} \setminus \{1\}$ .
3. The range of the symbol  $a$   $\mathcal{R}(a)$  is a closed Jordan curve without loops and winding number  $-1$  around each interior point.

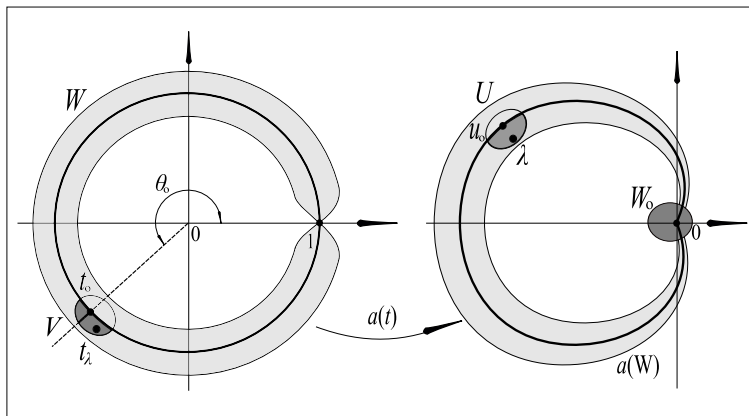

Figure: The map  $a(t)$  over the unit circle.

# Symbols with Fisher–Hartung singularity.

$$a_{\alpha,\beta}(t) = (1-t)^\alpha (-t)^\beta, \quad 0 < \alpha < |\beta| < 1.$$

Conjecture of  
H.Dai, Z.Geary and L.P.Kadanoff, 2009

$$\lambda_j^{(n)} \sim a_{\alpha,\beta} \left( w_j \cdot \exp \left\{ (2\alpha + 1) \frac{\log}{n} \right\} \right)$$

where  $w_j = \exp \left( -i \frac{2\pi j}{n} \right)$ .

### Lemma (3)

Let  $a(t) = t^{-1}h(t)$  be a symbol that satisfies the following conditions:

1.  $h \in H^\infty$ .
2.  $\mathcal{R}(a)$  is a closed Jordan curve in  $\mathbb{C}$  without loops.
3.  $\text{wind}_\lambda(a) = -1$ , for each  $\lambda$  in the interior of  $\text{sp } T(a)$ .

Then, for each  $\lambda$  in the interior of  $\text{sp } T(a)$ , we have the equality

$$D_n(a - \lambda) = (-1)^n h_0^{n+1} \left[ \frac{1}{h(t) - \lambda t} \right]_n,$$

for every  $n \in \mathbb{N}$ .

*Proof.*

$$T_{n+1}(h - \lambda t) = \left[ \begin{array}{ccccc|c} h_0 & 0 & 0 & \cdots & 0 & 0 \\ \hline h_1 - \lambda & h_0 & 0 & \cdots & 0 & 0 \\ h_2 & h_1 - \lambda & h_0 & \cdots & 0 & 0 \\ \vdots & \vdots & \vdots & \ddots & \vdots & \vdots \\ h_{n-1} & h_{n-2} & h_{n-3} & \cdots & h_0 & 0 \\ h_n & h_{n-1} & h_{n-2} & \cdots & h_1 - \lambda & h_0 \end{array} \right] \quad (66)$$

and

$$T_n(a - \lambda) = \left[ \begin{array}{ccccc} h_1 - \lambda & h_0 & 0 & \cdots & 0 \\ h_2 & h_1 - \lambda & h_0 & \cdots & 0 \\ \vdots & \vdots & \vdots & \ddots & \vdots \\ h_{n-1} & h_{n-2} & h_{n-3} & \cdots & h_0 \\ h_n & h_{n-1} & h_{n-2} & \cdots & h_1 - \lambda \end{array} \right].$$

Applying Cramer's rule to (66) we obtain

$$\left[ T_{n+1}^{-1}(h - \lambda t) \right]_{(n+1,1)} = (-1)^{n+2} \frac{D_n(a - \lambda)}{D_{n+1}(h - \lambda t)}. \quad (67)$$

We claim that  $h(t) - \lambda t$  is invertible in  $H^\infty$ . To see this, we must show that  $h(t) \neq \lambda t$  for all  $t \in \overline{\mathbb{D}}$  and each  $l \in \mathcal{D}(a)$ . Let  $l$  be a point in  $\mathcal{D}(a)$ . For each  $t \in \mathbb{T}$  we have  $h(t) \neq \lambda t$  because  $\lambda \notin \partial\mathcal{D}(a) = \mathcal{R}(a)$ . By assumption,  $\text{wind}_\lambda(a) = -1$  and thus,

$$\begin{aligned} -1 &= \text{wind}_0(a - \lambda) = \text{wind}_0(t^{-1}h(t) - \lambda) = \text{wind}_0(t^{-1}(h(t) - \lambda t)) \\ &= \text{wind}_0(t^{-1}) + \text{wind}_0(h(t) - \lambda t) = -1 + \text{wind}_0(h(t) - \lambda t). \end{aligned}$$

It follows that  $\text{wind}_0(h(t) - \lambda t) = 0$ , which means that the origin does not belong to the inside domain of the curve  $\{h(t) - \lambda t: t \in \mathbb{T}\}$ . As  $h \in H^\infty$ , this shows that  $h(t) \neq \lambda t$  for all  $t \in \mathbb{D}$  and proves our claim.

If  $b$  is invertible in  $H^\infty$ , then  $T_{n+1}^{-1}(b) = T_{n+1}(1/b)$ . Thus the  $(n+1, 1)$  entry of the matrix  $T_{n+1}^{-1}(h(t) - \lambda t)$  is in fact the  $n$ th Fourier coefficient of  $(h(t) - \lambda t)^{-1}$ ,

$$\left[ T_{n+1}^{-1}(h(t) - \lambda t) \right]_{(n+1,1)} = \left[ \frac{1}{h(t) - \lambda t} \right]_n.$$

Inserting this in (67) we obtain

$$D_n(a - \lambda) = (-1)^{n+2} D_{n+1}(h(t) - \lambda t) \left[ \frac{1}{h(t) - \lambda t} \right]_n = (-1)^n h_0^{n+1} \left[ \frac{1}{h(t) - \lambda t} \right]_n,$$

which completes the proof.



## Theorem (6)

Let  $a$  be the symbol  $a(t) = t^{-1}h(t)$  where  $h$  satisfies the following conditions:

1.  $h \in H^\infty$ .
2.  $h(t) = (1-t)^\alpha f(t)$  with  $\alpha \in \mathbb{R}_+ \setminus \mathbb{N}$  and  $f(e^{i\theta}) \in C^\infty(-\pi, \pi]$ .
3.  $h$  has an analytic extension to a neighborhood  $W$  of  $\mathbb{T} \setminus \{1\}$ .
4.  $\mathcal{R}(a)$  is a closed Jordan curve in  $\mathbb{C}$  without loops.
5.  $\text{wind}_\lambda(a) = -1$ , for each  $\lambda$  in the interior of  $\text{sp } T(a)$ .

Then for every small neighborhood  $W_o$  of zero in  $\mathbb{C}$  and every  $\lambda \in \text{sp } T(a) \cap a(W)$  not contained in  $W_o$ , is

$$D_n(a - \lambda) = (-h_o)^{n+1} \left[ \frac{1}{t_\lambda^{n+2} a'(t_\lambda)} - \frac{f(1)\Gamma(\alpha + 1) \sin(\alpha\pi)}{\pi \lambda^2 n^{\alpha+1}} + R_9(n, \lambda) \right],$$

where  $R_9(n, \lambda) = \mathcal{O}(n^{-\alpha-\alpha_o-1})$ ,  $n \rightarrow \infty$ , uniformly with respect to  $\lambda$  in  $a(W)$ . Here  $\alpha_o = \min\{\alpha, 1\}$ .

## Theorem (7)

*Under the hypothesis of theorem (6) we have the following asymptotic expression for  $\lambda_j$ :*

$$\lambda_j = a(\omega_j) + (\alpha + 1)\omega_j a'(\omega_j) \frac{\log(n)}{n} + \frac{\omega_j a'(\omega_j)}{n} \log \left( \frac{a^2(\omega_j)}{c_0 a'(\omega_j) \omega_j^2} \right) + \mathcal{O} \left( \frac{\log(n)}{n} \right)^2, \quad n \rightarrow \infty.$$

$n = 4096$

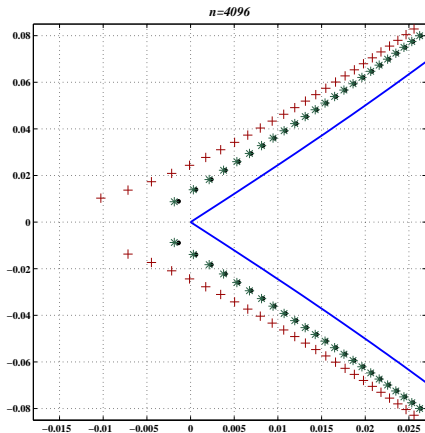

Figure: The solid blue line is the range of  $a$ . The black dots are  $\text{sp } T_n(a)$  calculated by *Matlab*. The red crosses and the green stars are the approximations, for 1 and 2 terms respectively. Here we took  $\alpha = 3/4$ .

$$n = 4096$$

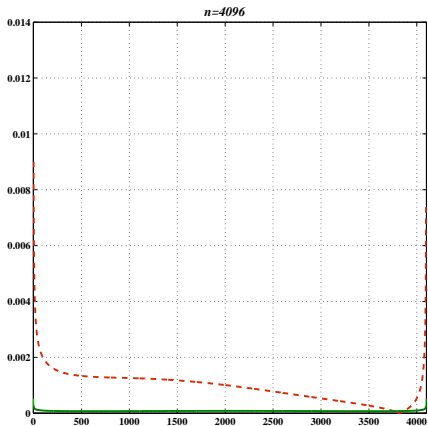

Figure: The dotted red and solid green lines, are the errors of the approximations, with 1 and 2 terms respectively. Here we took  $\alpha = 3/4$ .